Pulse Sequences: EPG and Simulations

M229 Advanced Topics in MRI

Holden H. Wu, Ph.D.

2020.04.09

UCLA

*Department of Radiological Sciences
David Geffen School of Medicine at UCLA*

Class Business

- Office hours
 - Instructor
 - TA for HW1: 4/10, 4/17, 4/24
- Homework 1 due on 4/24 Fri
- Final project
 - Start thinking
 - Discuss over email or during office hours
 - Discussion in class on 4/23 Thu

Outline

- Multi-Pulse Experiments
- Extended Phase Graphs (EPG)
- EPG Simulations
 - Homework 1
- Spin Bench

Multi-Pulse Experiments

- Multiple RF pulses
 - always have echoes (many types)
 - do not need perfect $90^\circ+180^\circ$ to form SE, etc.
- Analysis
 - Bloch Equations
 - Extended Phase Graphs (EPG)

Spin Echo (2 pulses)

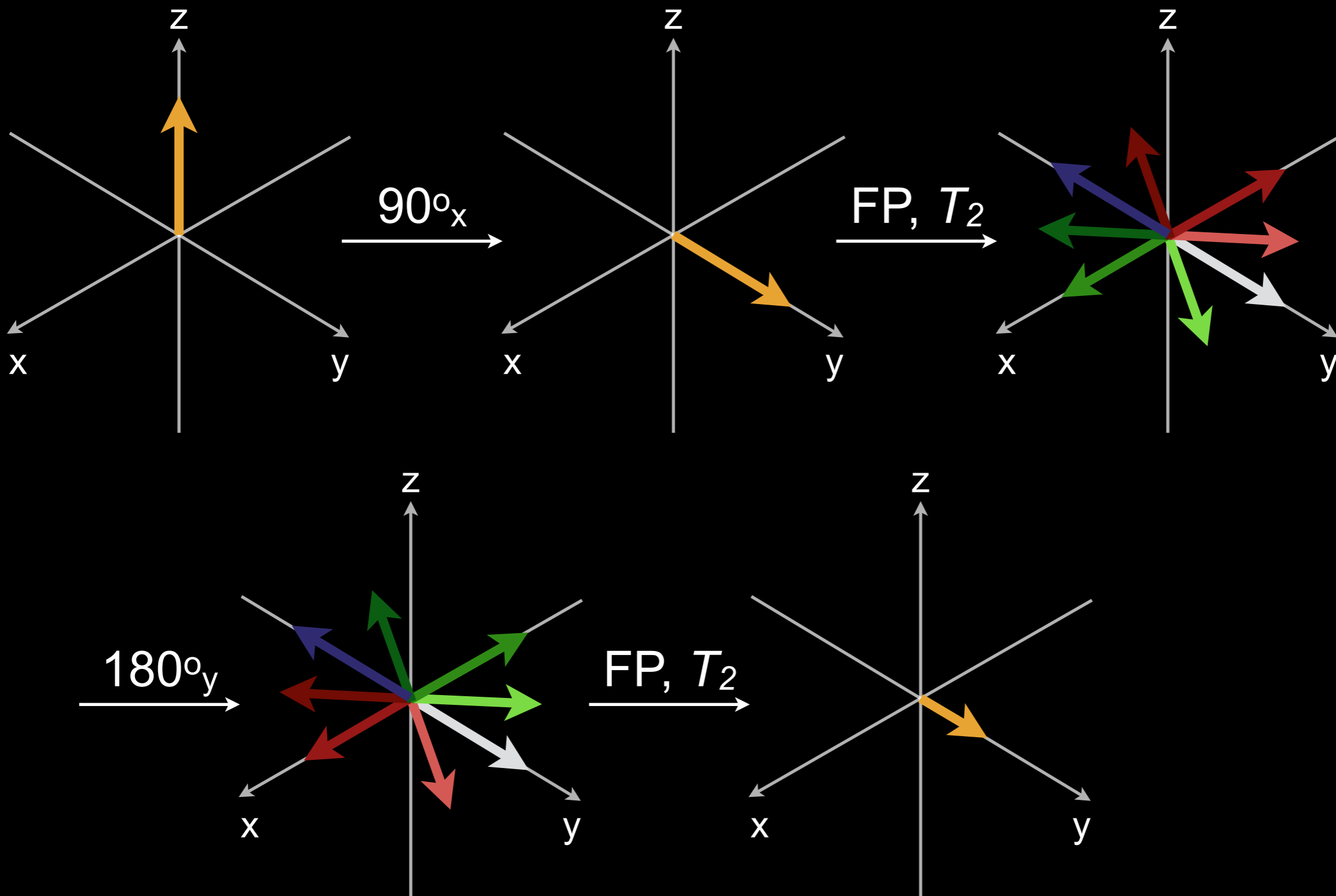

Stimulated Echo (3 pulses)

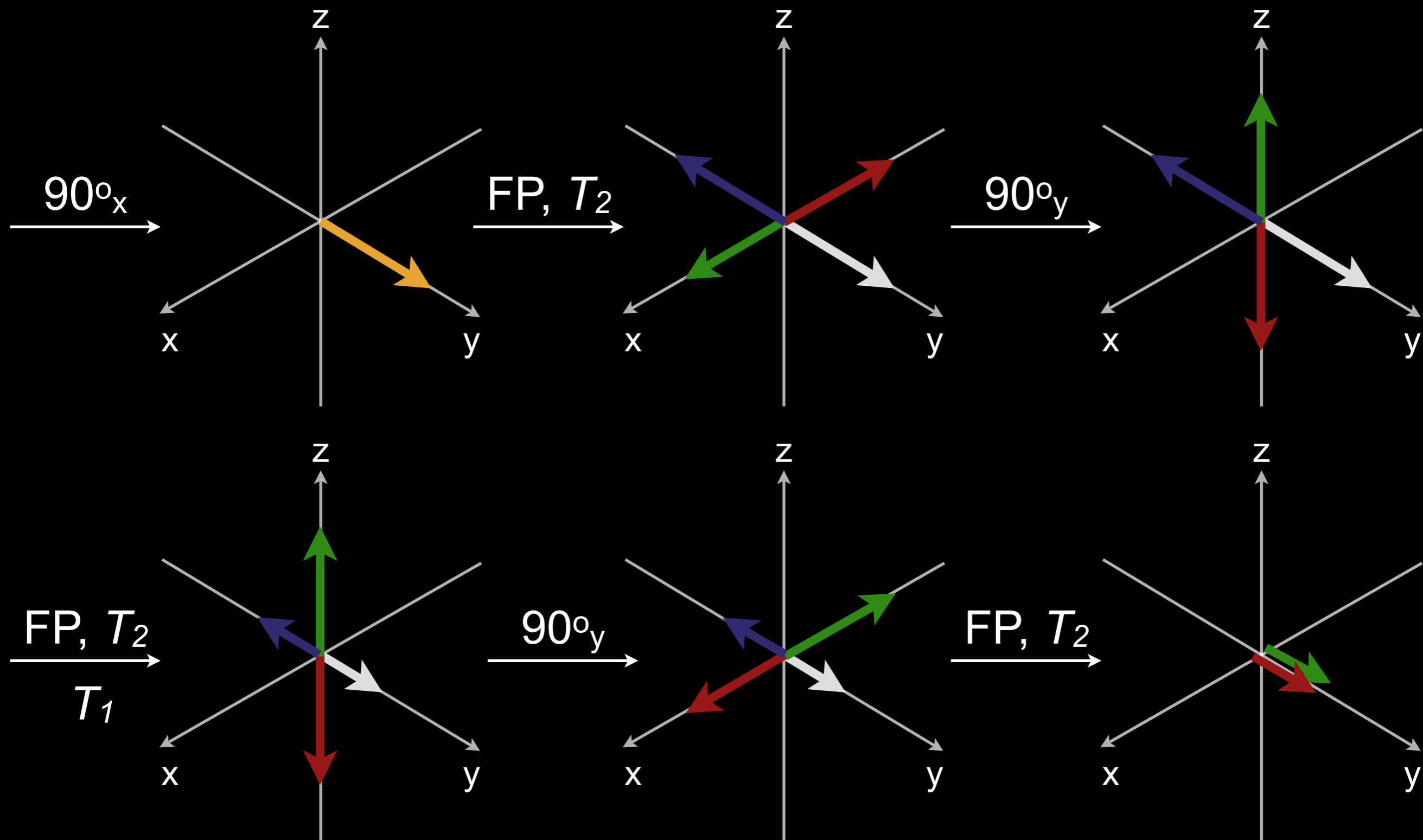

Multiple Pulse Experiments

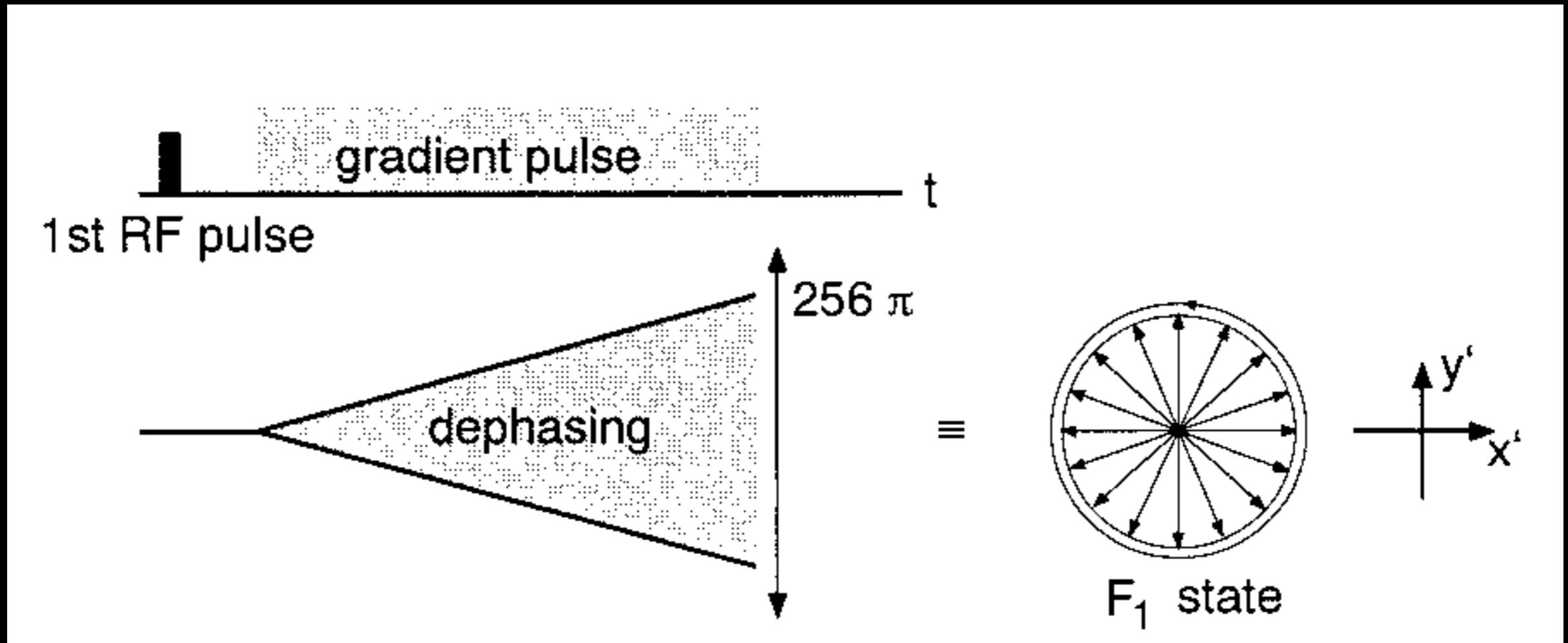

Multiple Pulse Experiments

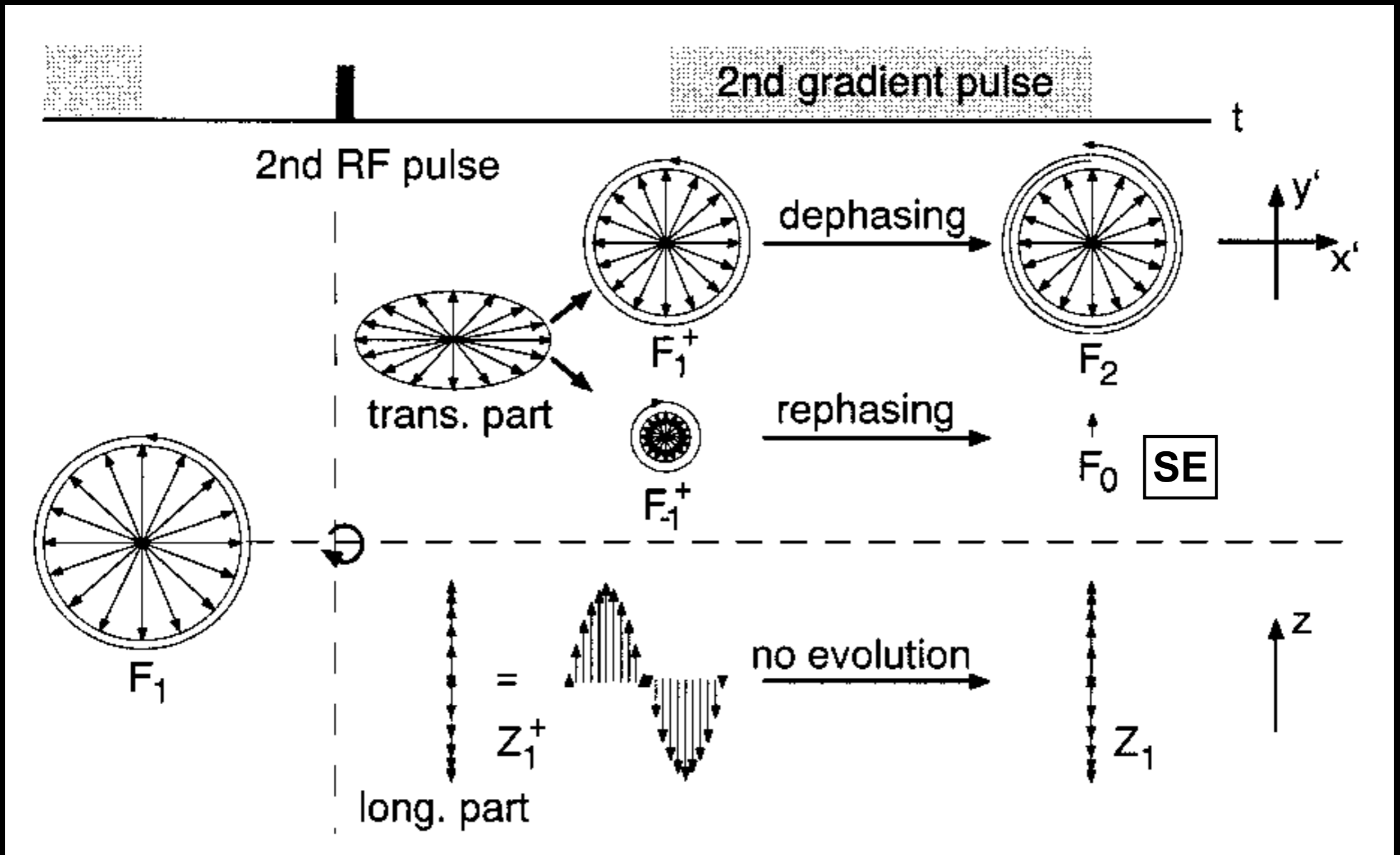

Multiple Pulse Experiments

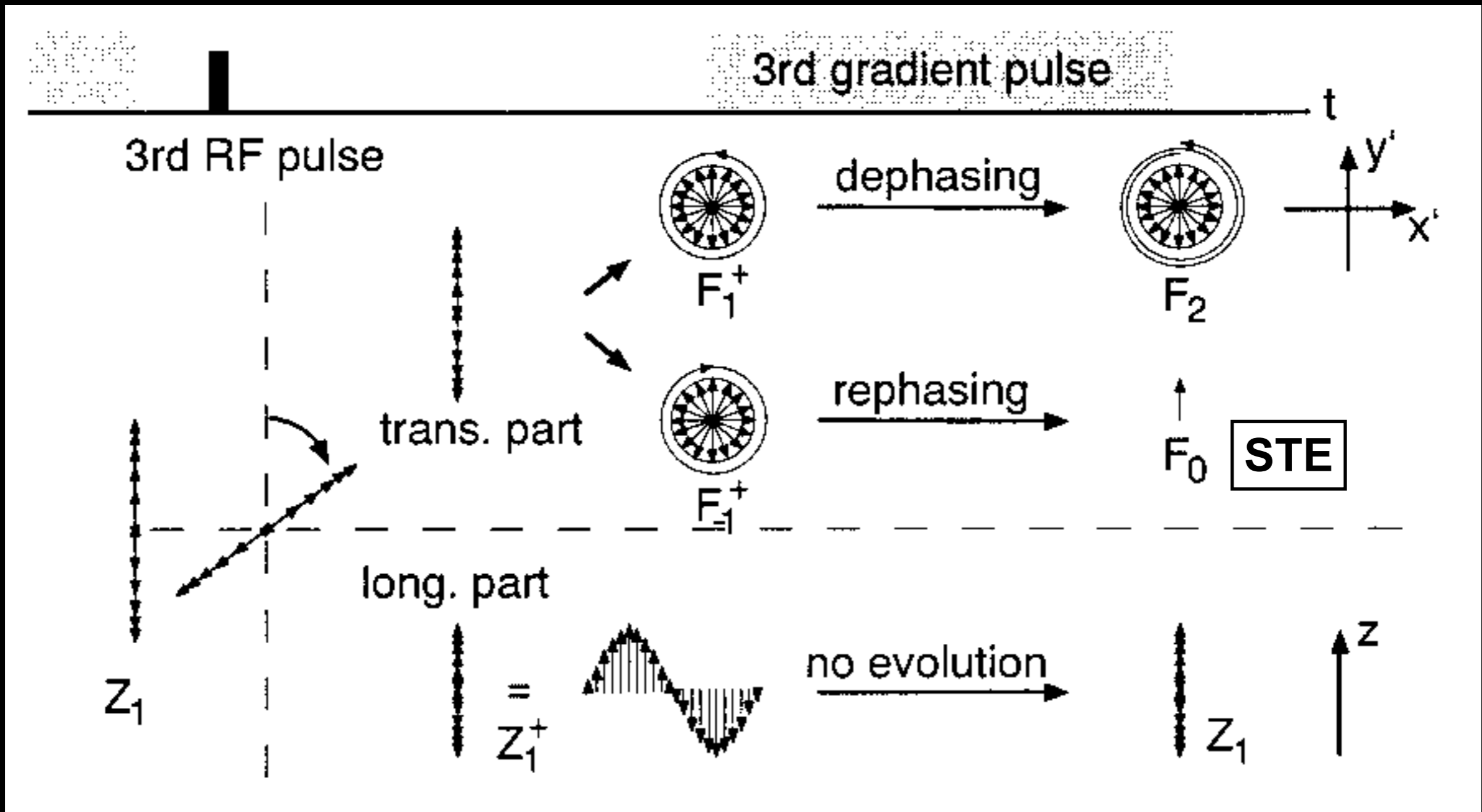

Multiple Pulse Experiments

- RF pulses act on an ensemble of spins
 - M_z to M_{xy}
 - M_{xy} to M_z , M_{xy} and M_{xy}^*
- Transverse F states
 - $F = M_x + iM_y = F_{pos}$; $F^* = M_x - iM_y = F_{neg}$
- Longitudinal Z states

Multiple Pulse Experiments

Signal Pathways on a Phase Diagram (i.e. EPG)

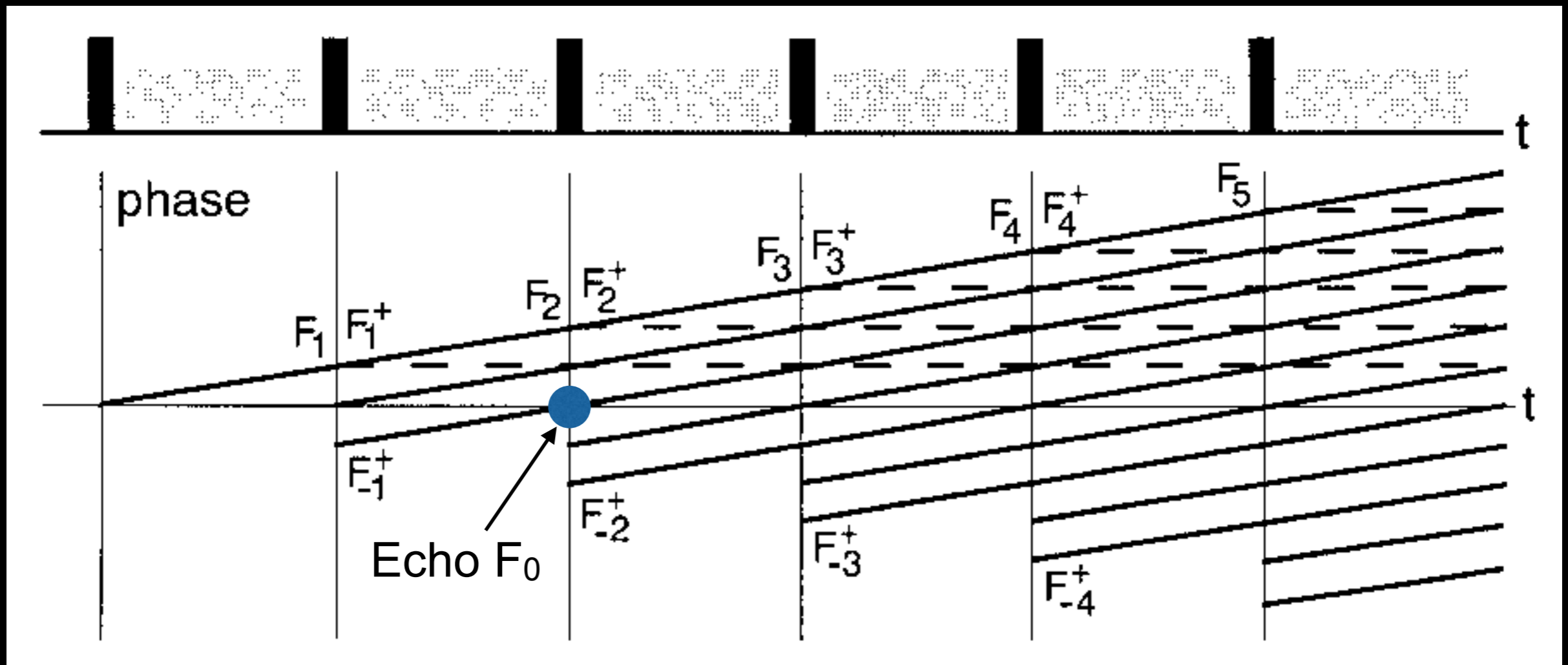

Z states appear as broken lines; F_0 states are echoes

Extended Phase Graphs

- MR signal is a sum of all dephased spins
- Bloch equation
 - tracks evolution of magnetization for each spin
 - exact, but hard to visualize intuitively
- EPG
 - considers groups of spins under constant gradients
 - decomposes the spin system into several dephased states: F_k and F_{-k} ; Z_k

Extended Phase Graphs

- Based on Fourier space coordinate k

$$k_n(t) = \gamma \int_{t'=0}^t G_n(t') dt' = \int_{t'=0}^t g_n(t') dt',$$

- Magnetization represented by Fourier transforms

$$F_+(\mathbf{k}) = \int_V \{M_x(\mathbf{r}) + iM_y(\mathbf{r})\} \exp(-i\mathbf{k}\mathbf{r}) d^3r,$$

$$F_-(\mathbf{k}) = \int_V \{M_x(\mathbf{r}) - iM_y(\mathbf{r})\} \exp(-i\mathbf{k}\mathbf{r}) d^3r,$$

$$Z(\mathbf{k}) = \int_V M_z(\mathbf{r}) \exp(-i\mathbf{k}\mathbf{r}) d^3r,$$

- Complete magnetization is described by vector \mathbf{F} of various EPG partitions states with different k

$$\mathbf{F} = (F_0 Z_0 F_1 F_{-1} Z_1 F_2 F_{-2} Z_2 \cdots F_{+k} F_{-k} Z_k)^T.$$

Gradient Dephasing

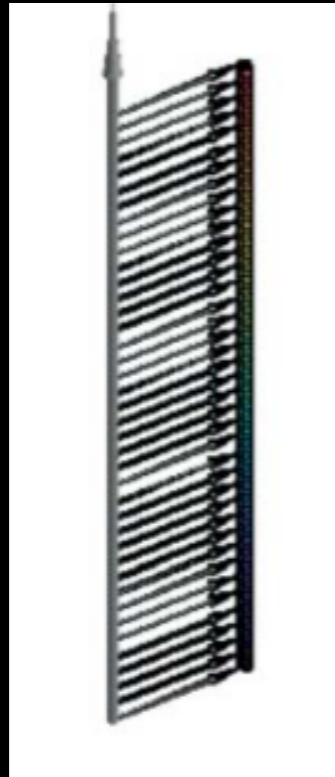

Gradient Dephasing

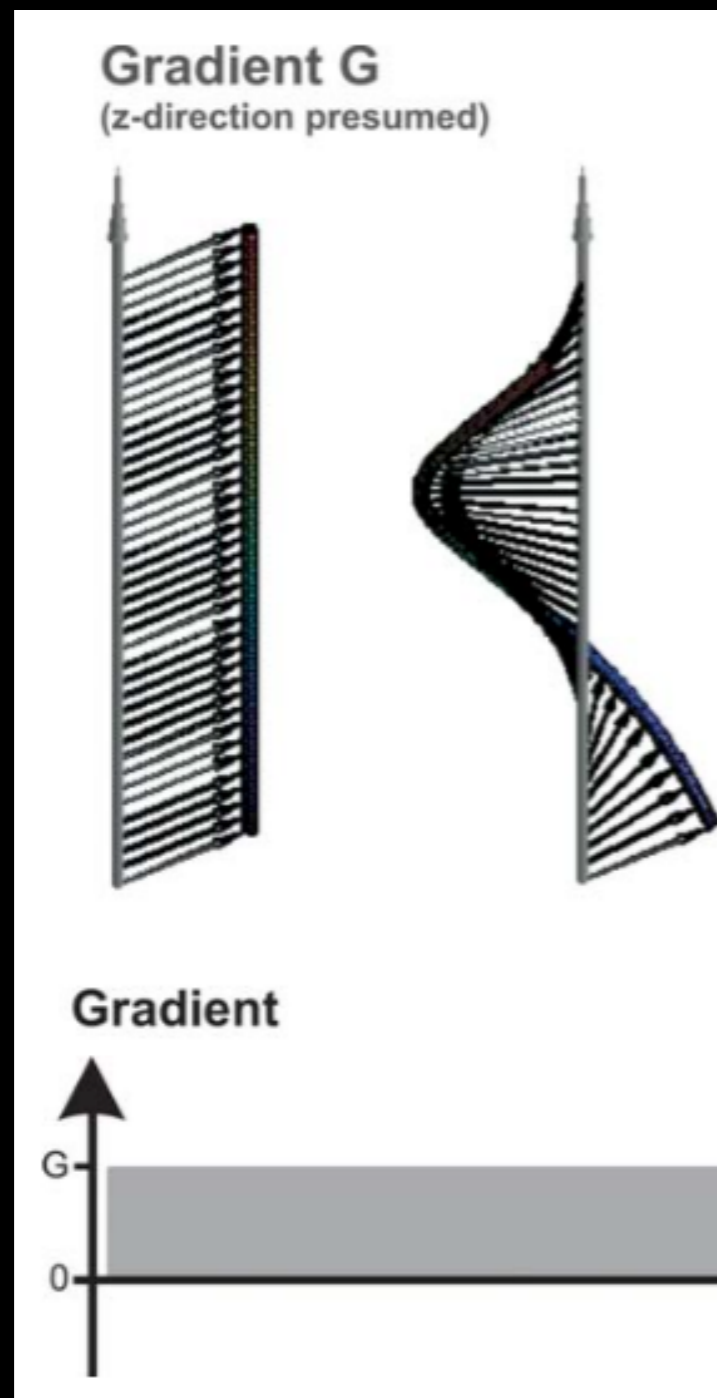

Gradient Dephasing

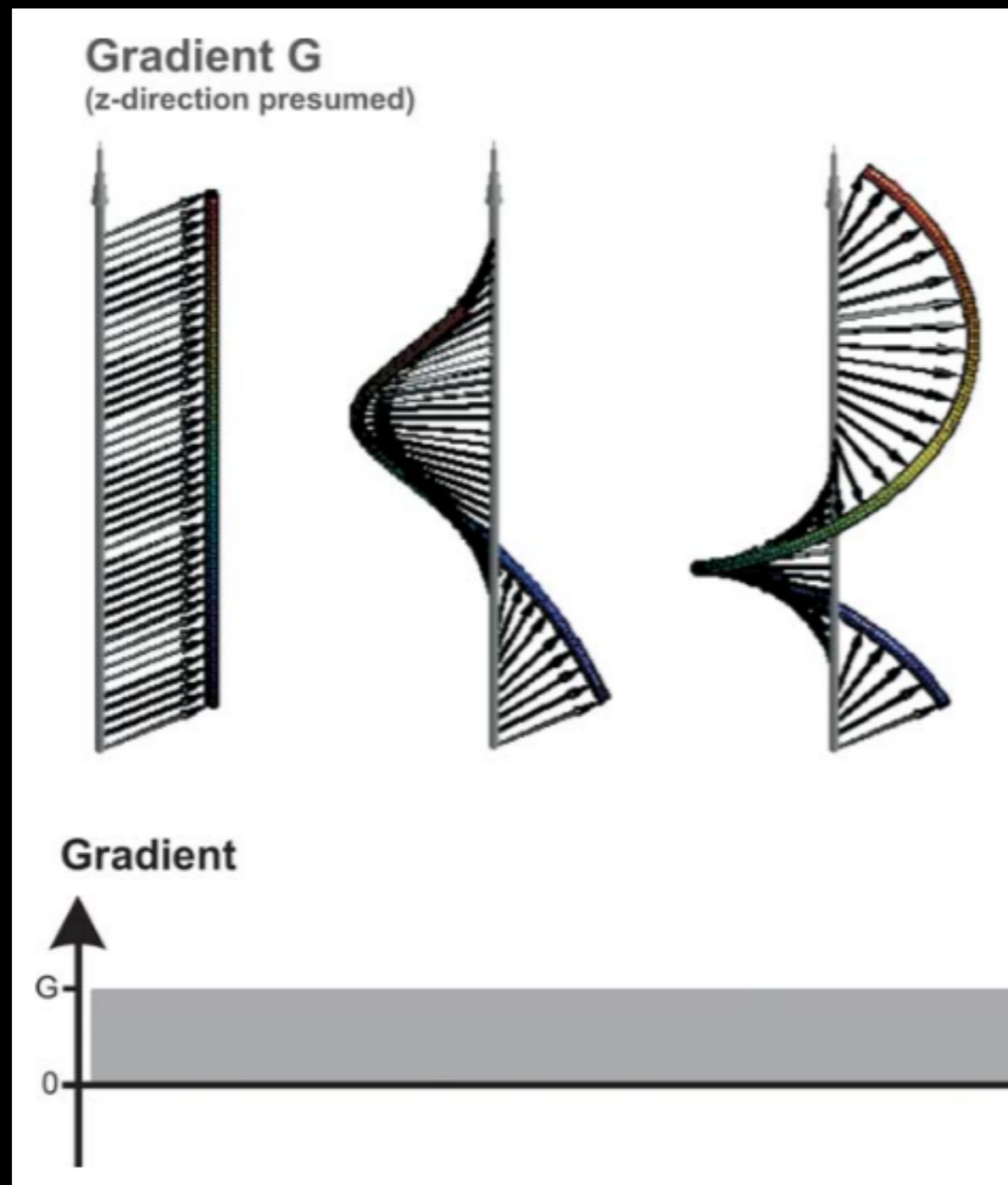

Gradient Dephasing

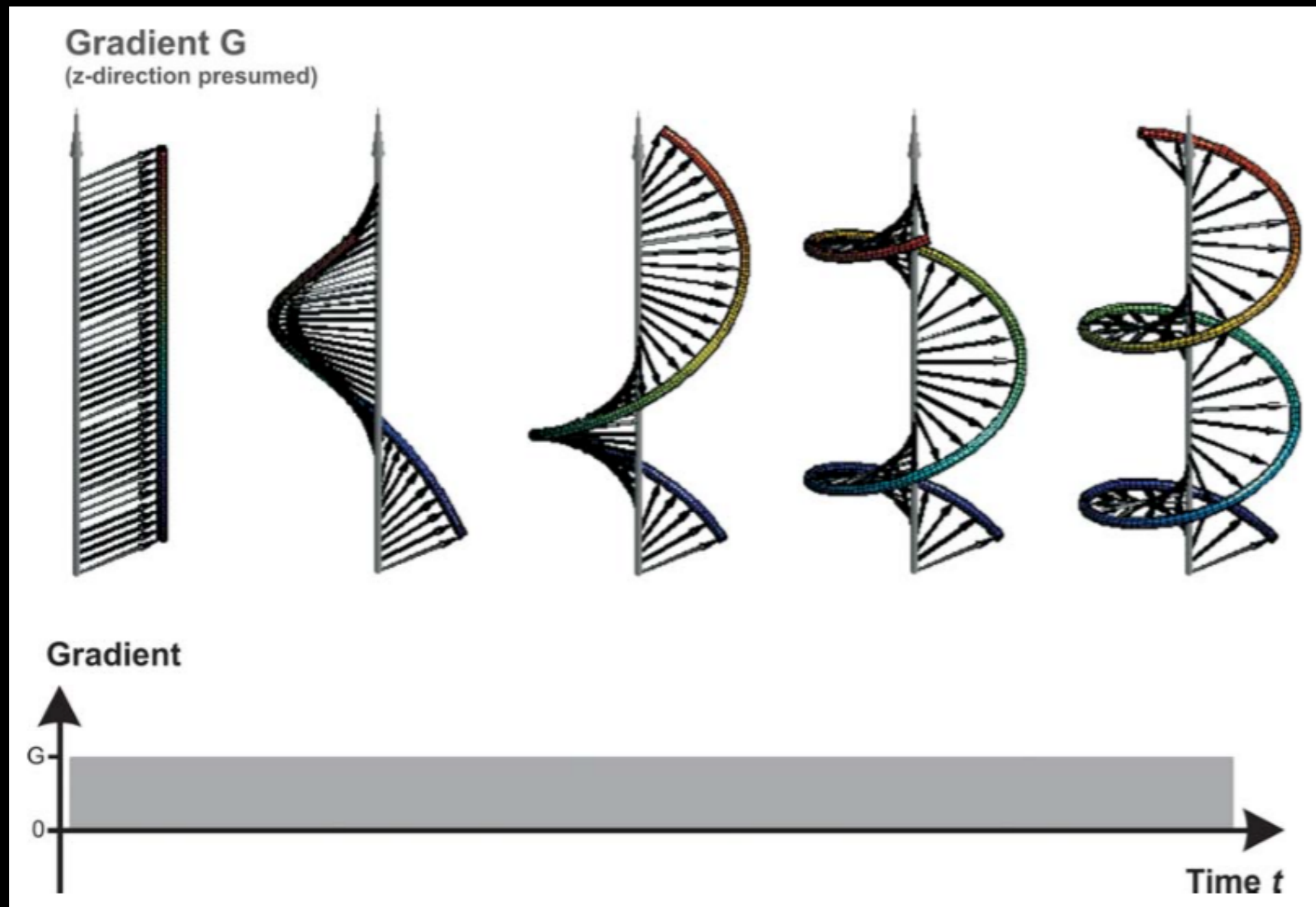

Gradient G

(z-direction presumed)

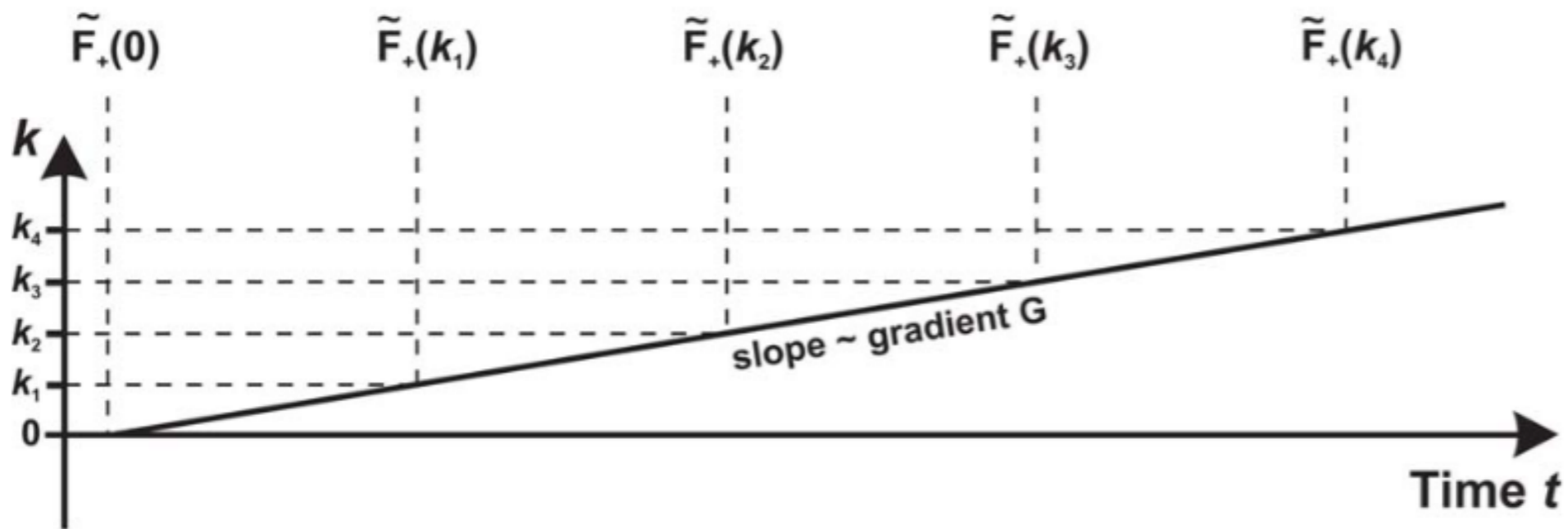
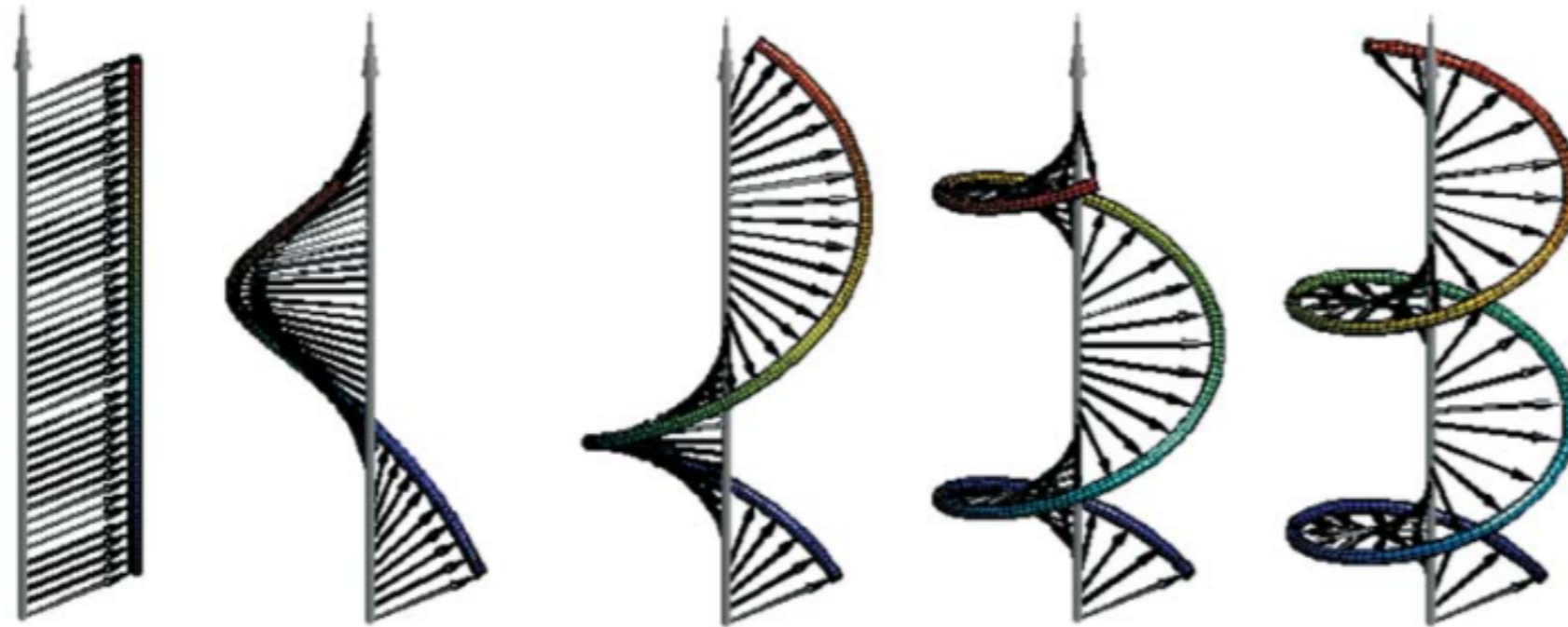

Gradient Dephasing

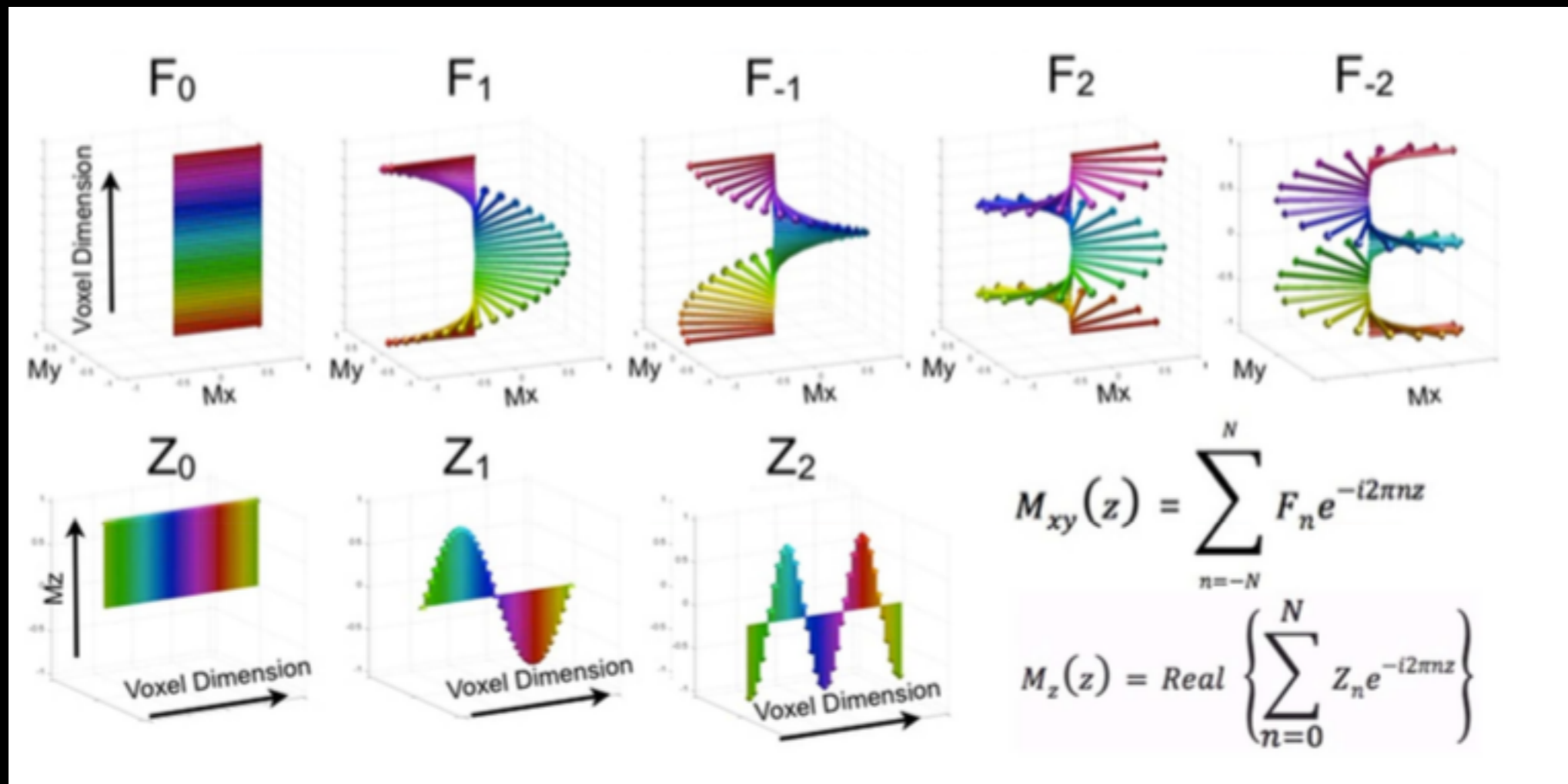

“Discrete” Gradient Dephasing

transition between states

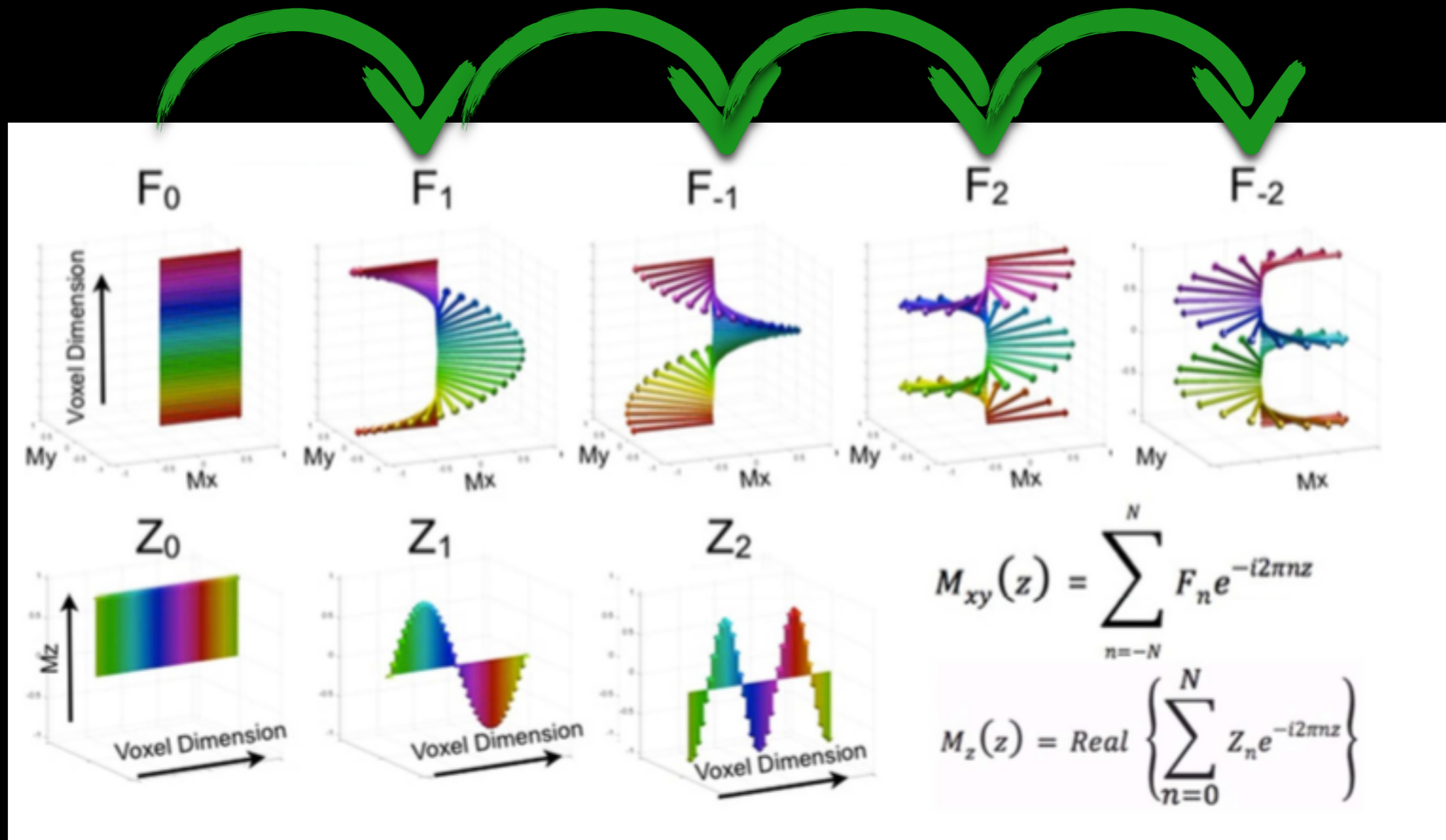

k is the number of twists/cycles across a voxel

RF Pulse

- Woessner Decomposition
magnetization after an RF pulse can be regarded as a composition of 3 components:
 - transversal component that is unaffected (0° -pulse)
 - transversal component that is refocused (180° -pulse)
 - a longitudinal component

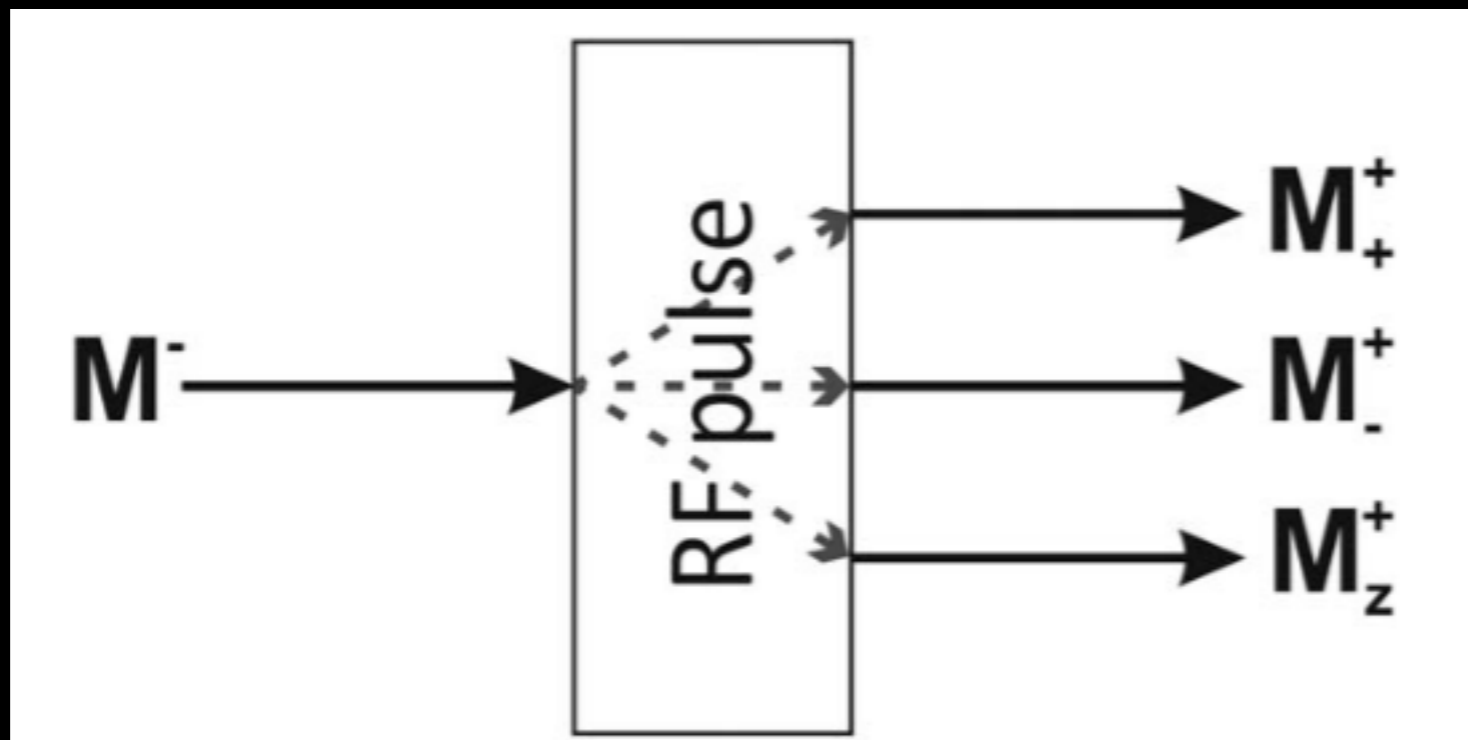

rephasing

dephasing

longitudinal

RF Pulse

- The RF pulse operator splits any given EPG state with dephasing order k into 3 different new states:
 - a transversal state with identical k
 - a transversal state with inverted k
 - a longitudinal state with identical k

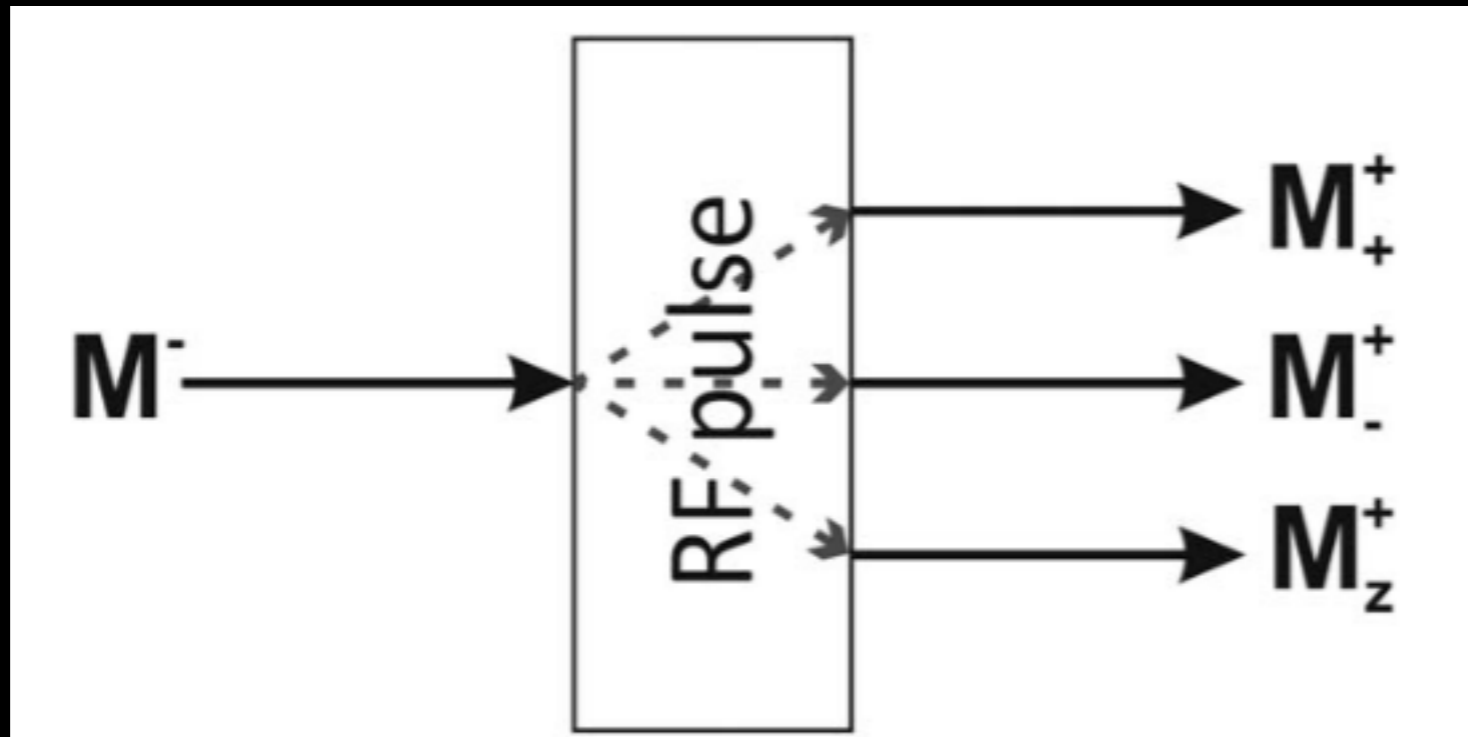

RF Pulse

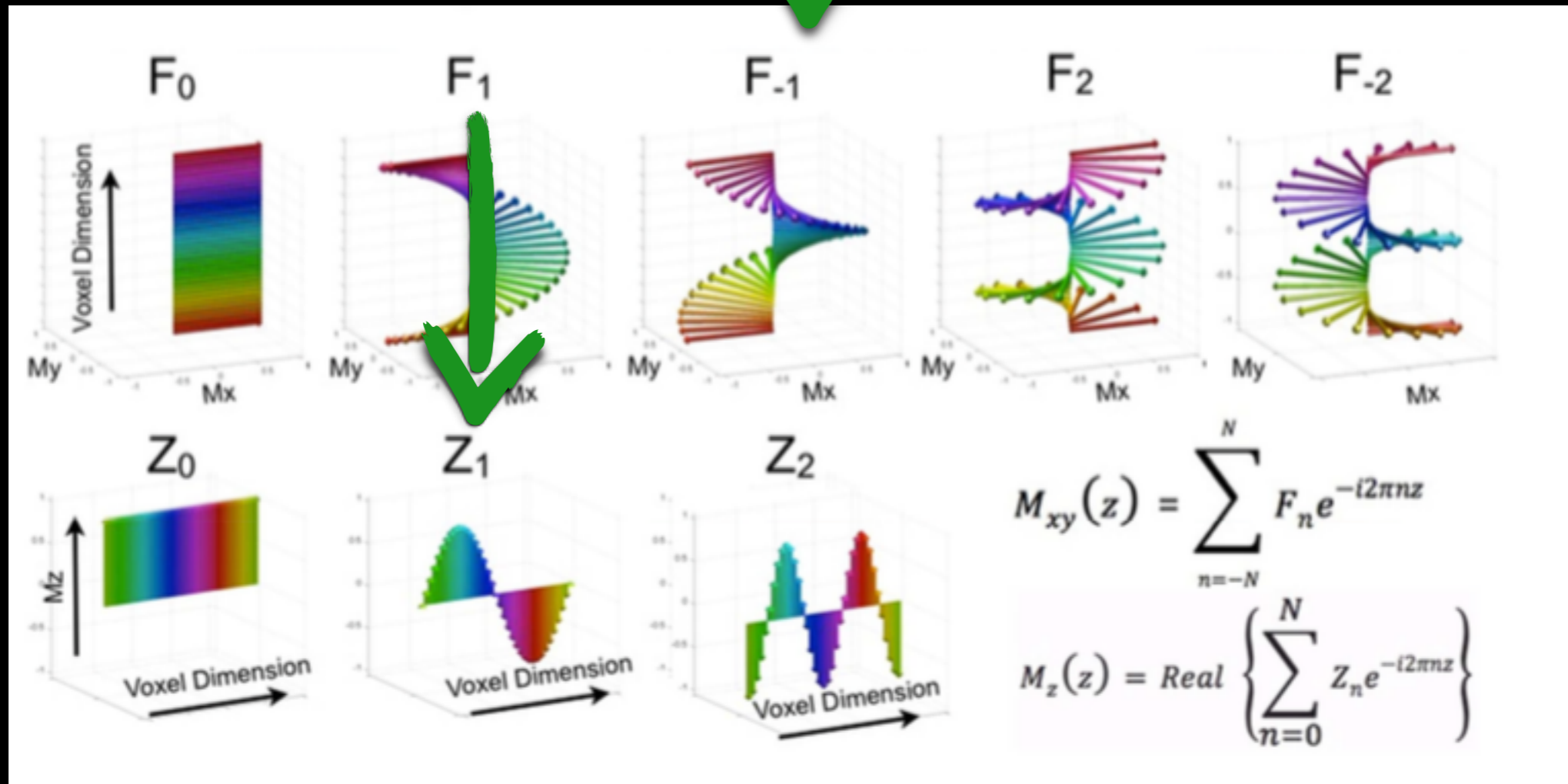

mixes F and Z states!

RF Pulse

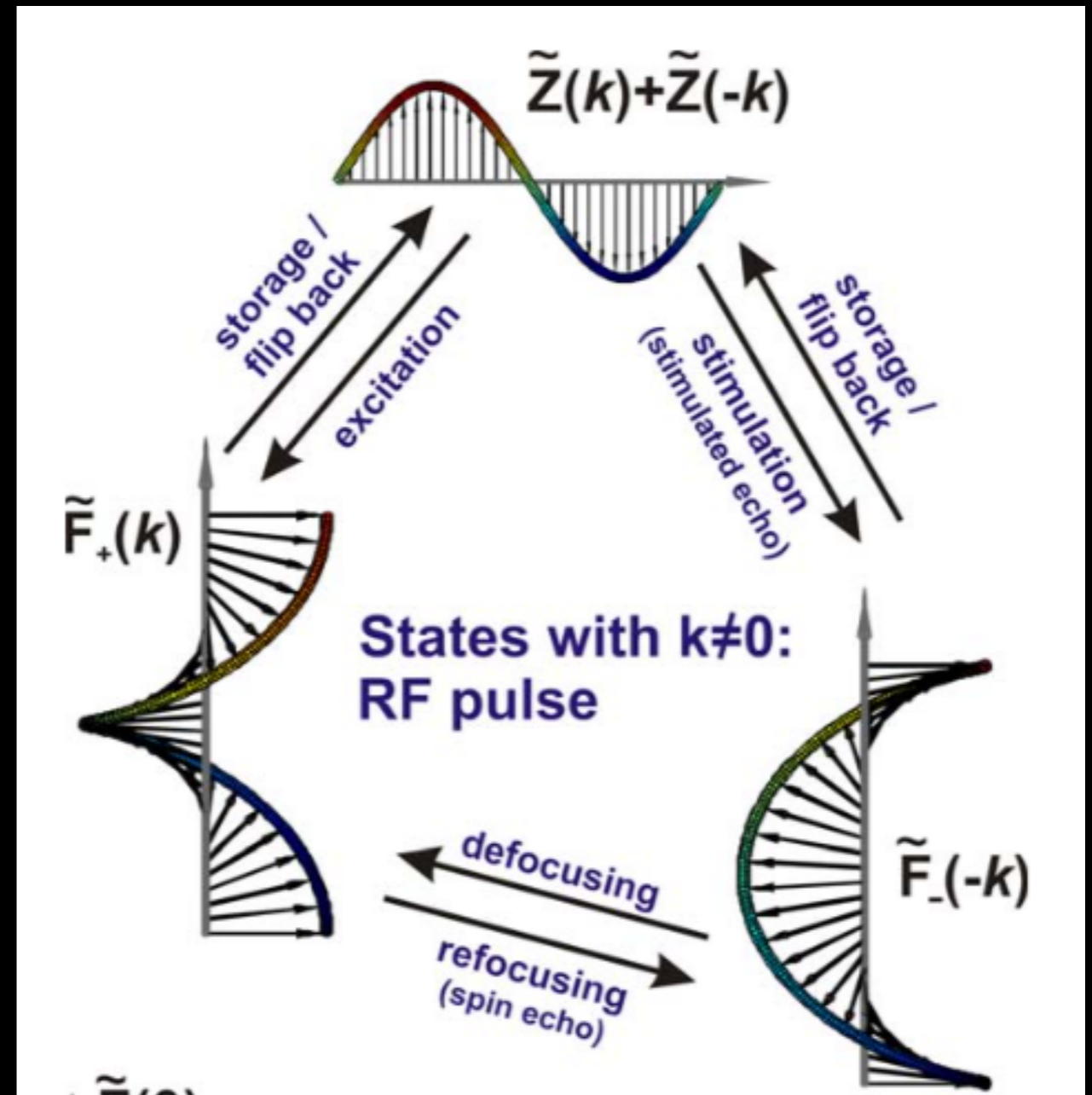
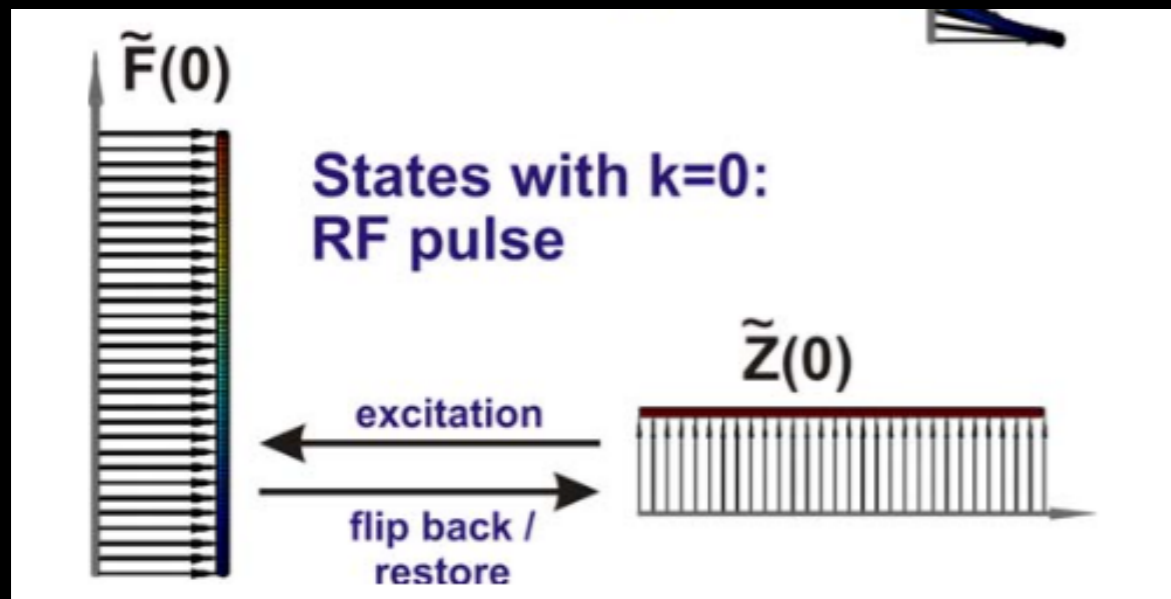
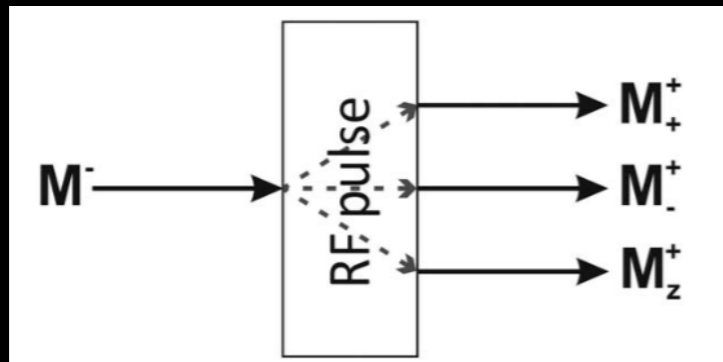

EPG Concept Summary

Fourier based configuration states

RF pulse partitioning

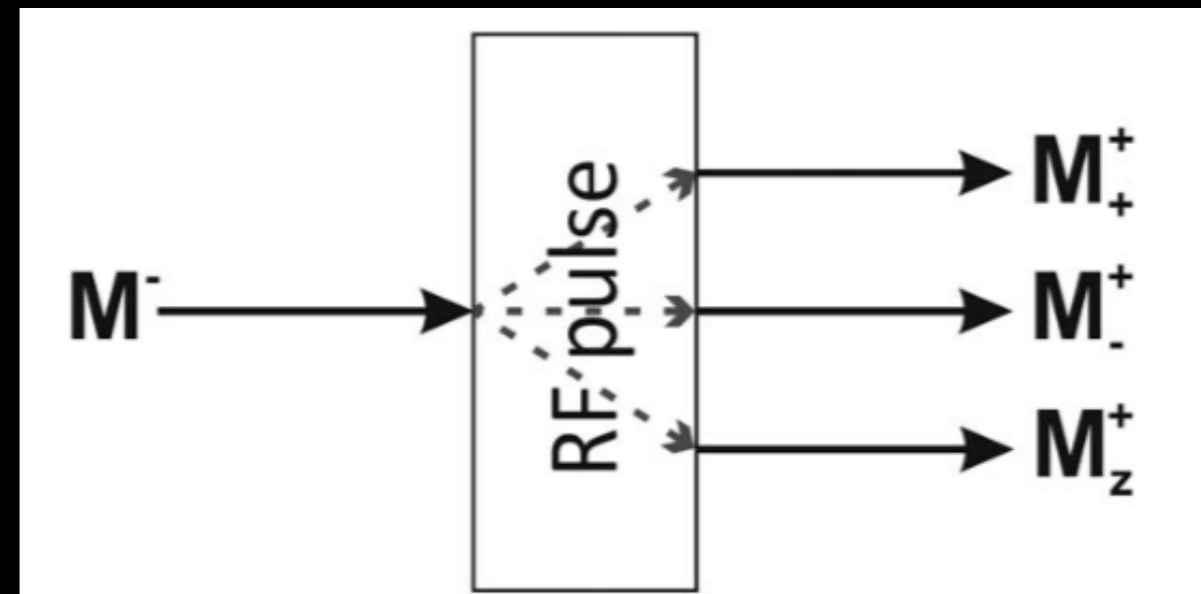
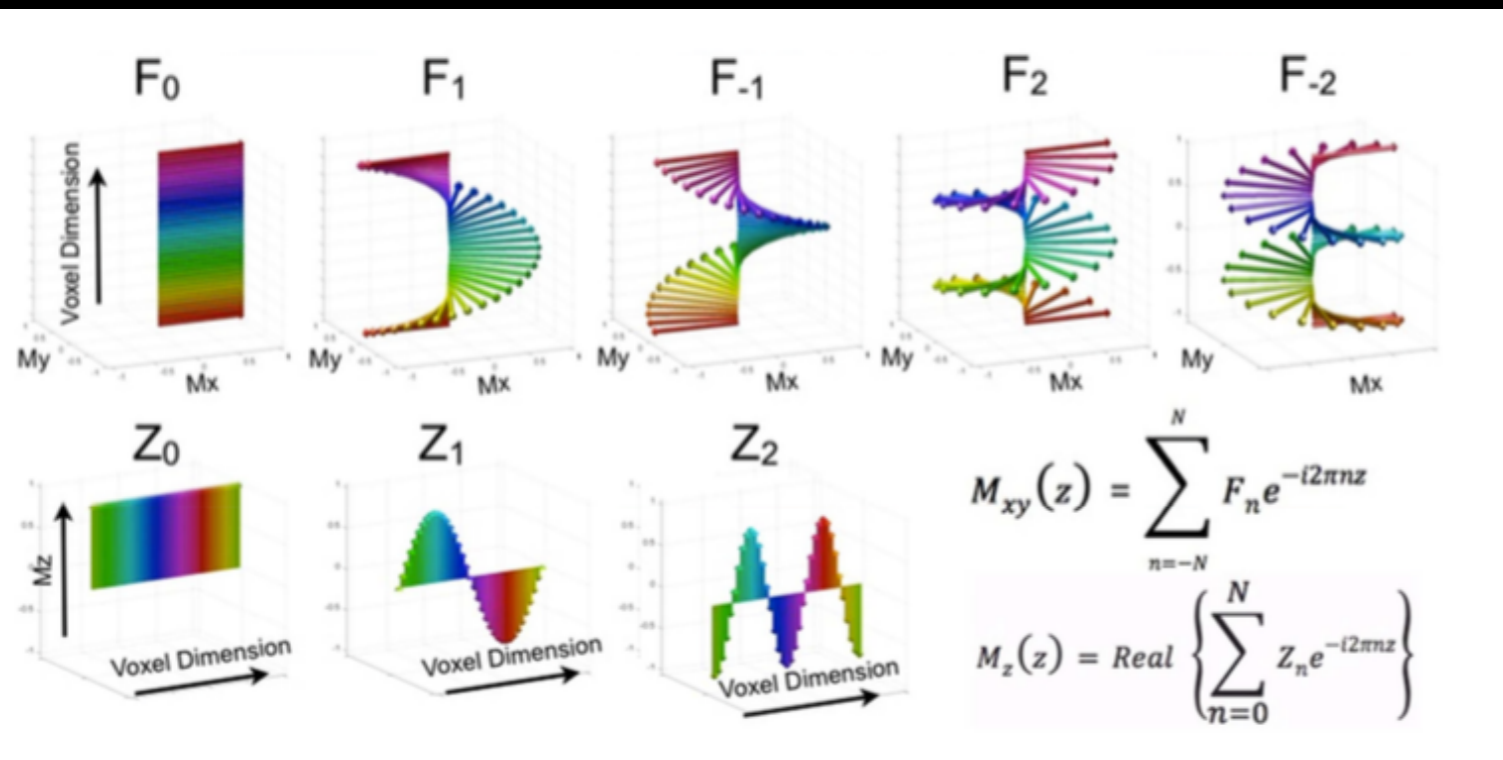

Phase graph approach that depicts the evolution of a complete isochromat ensemble.

EPG “Calculus”

- RF pulse for state k :
 - Produces signal in longitudinal state k and transverse states k and $-k$

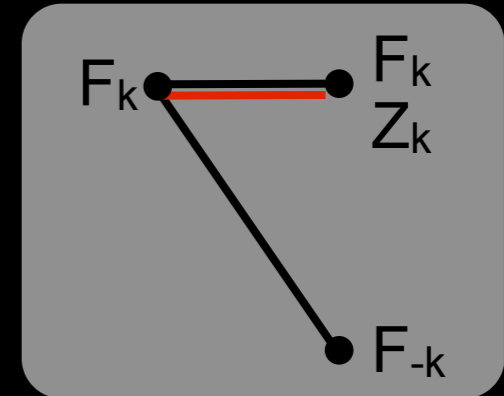

- Gradient dephaser for state k :
 - Moves transverse magnetization to $k+1$
 - Does not affect longitudinal magnetization

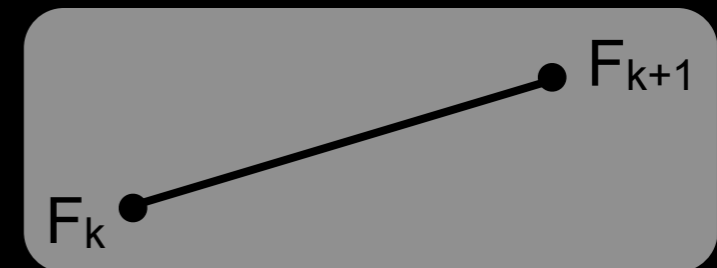

EPG: Spin Echo

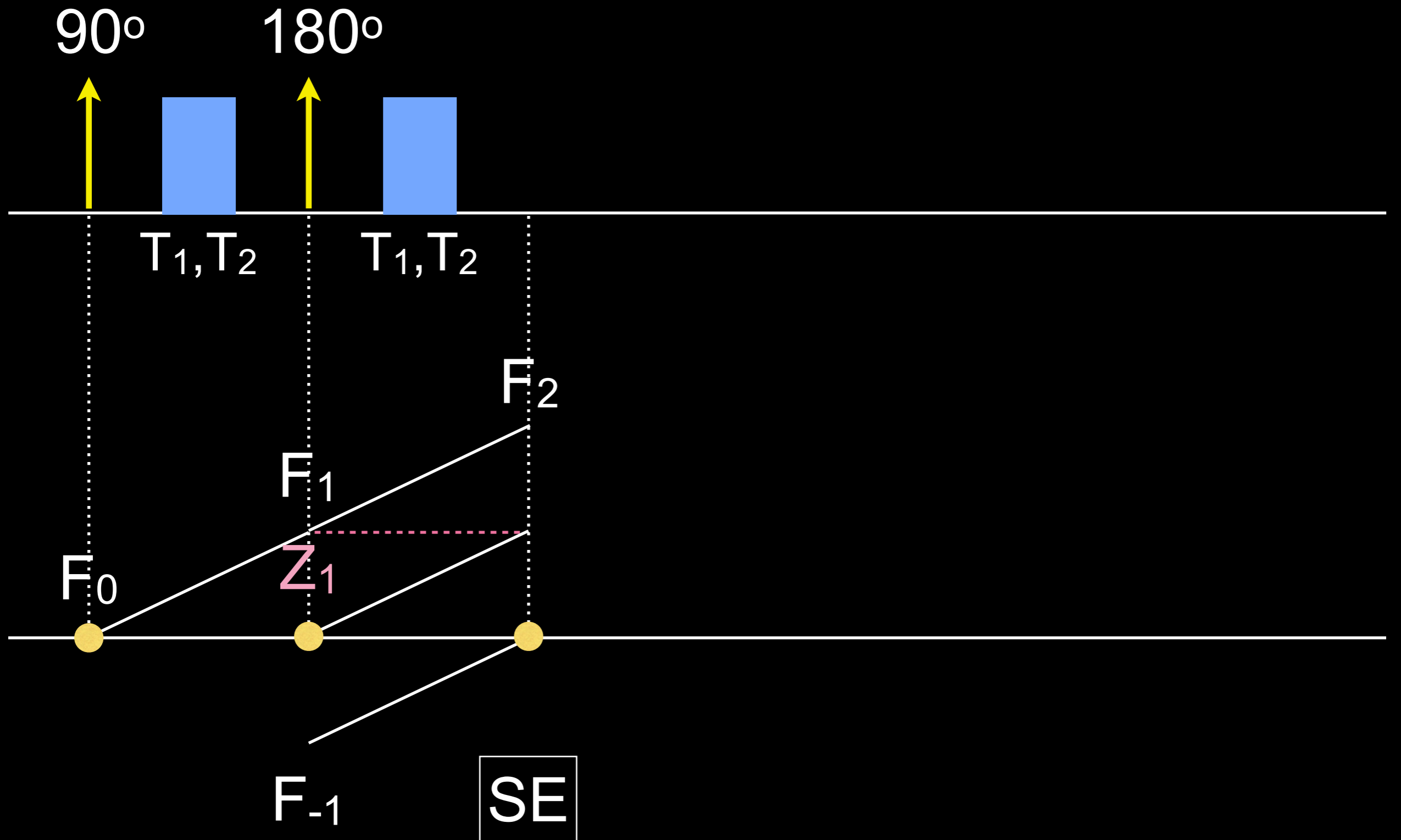

EPG: Stimulated Echo

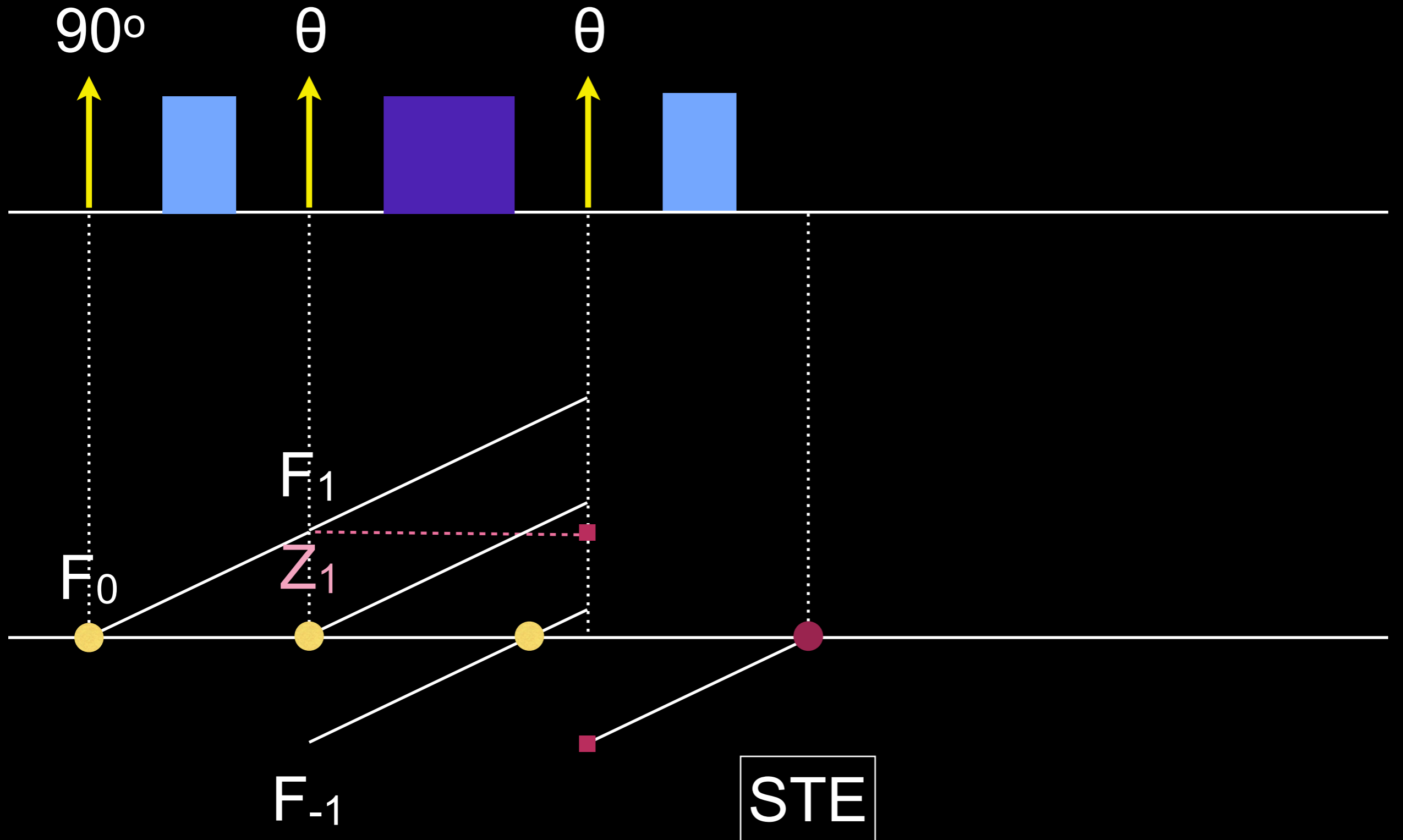

EPG: 3-Pulse Experiment

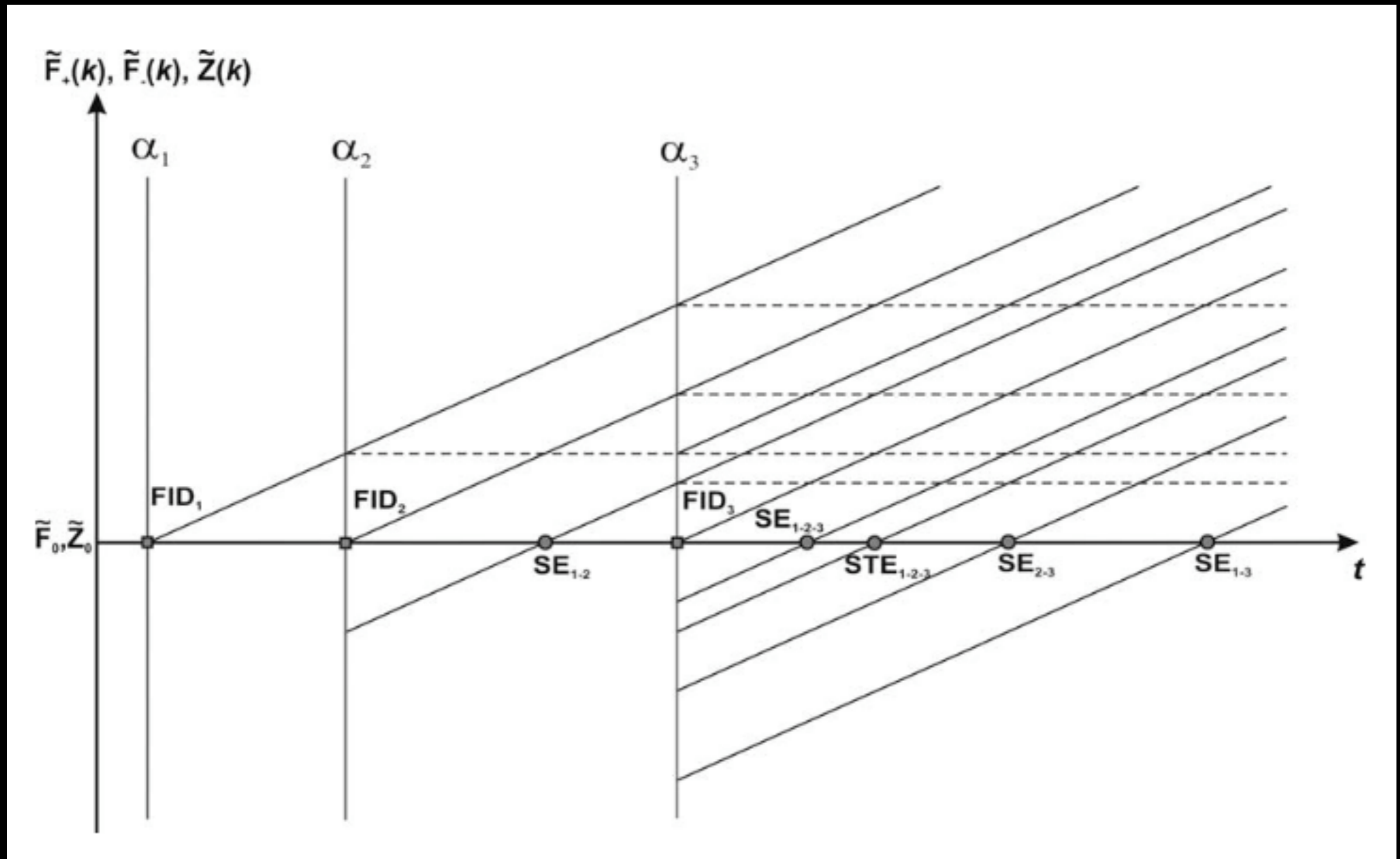

EPG: Train of Spin Echo

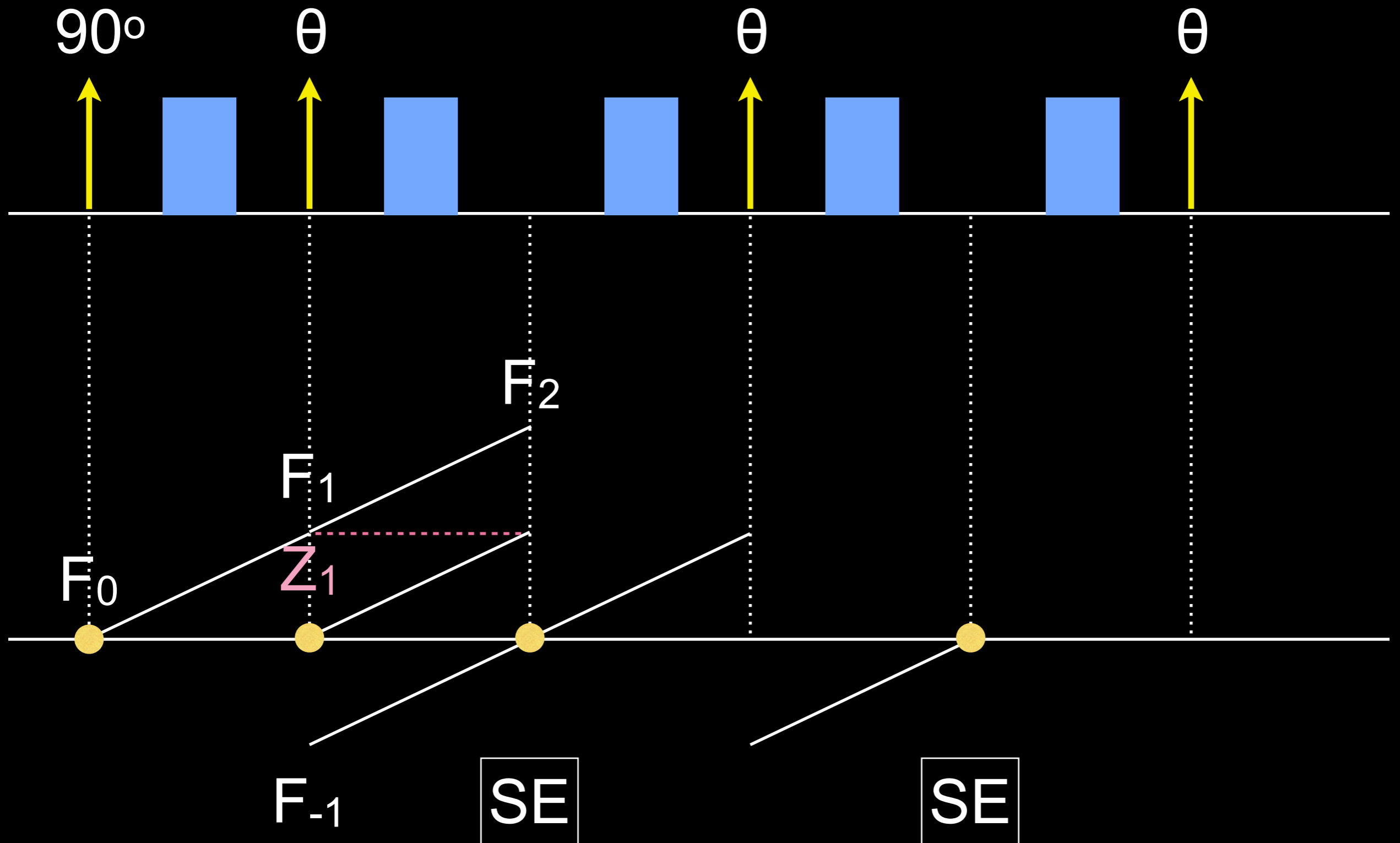

EPG: CPMG

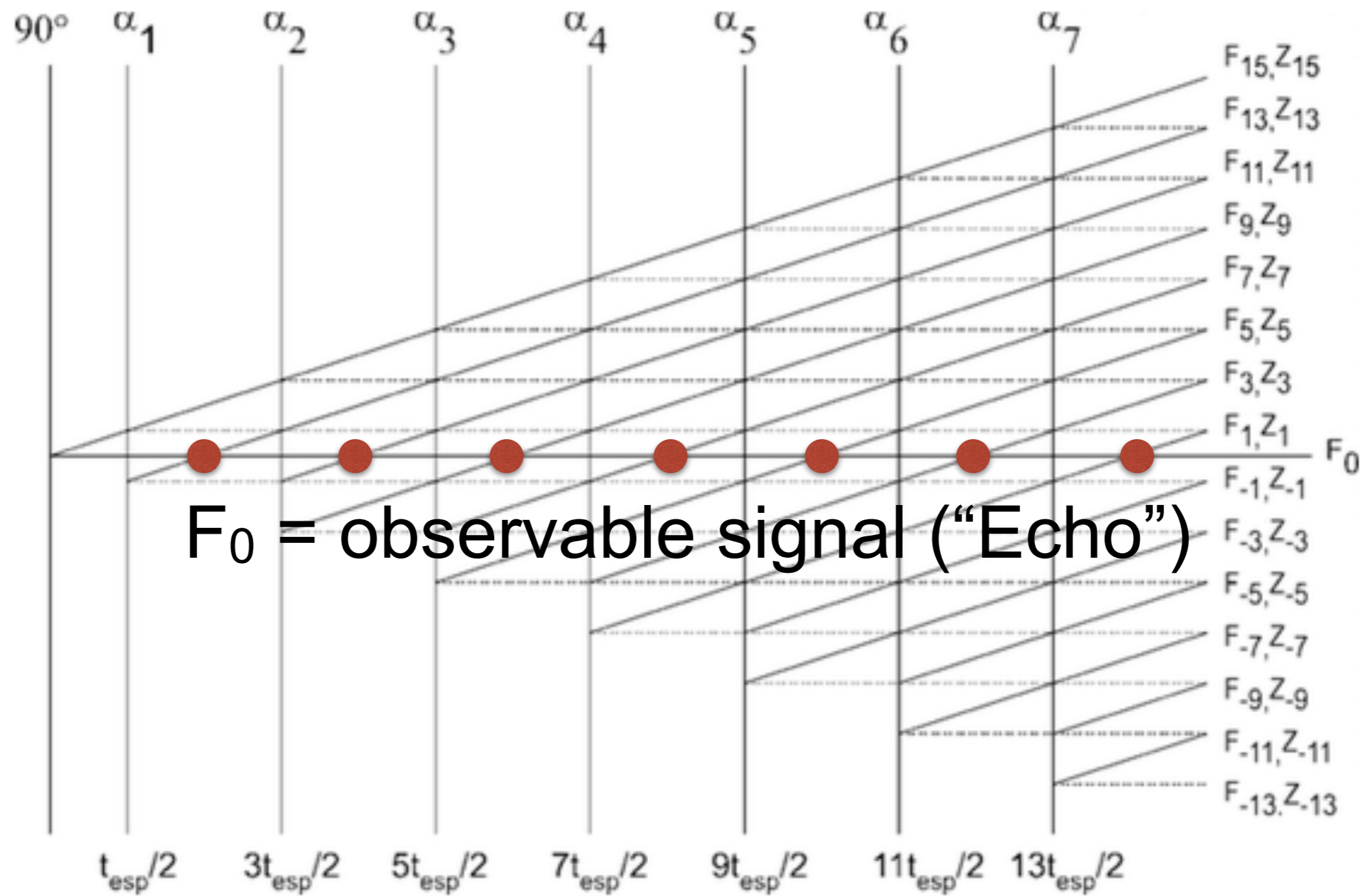

EPG: Matrix formulation

- Phase states
 - Can represent as a matrix:

$$P = \begin{bmatrix} F_0 & F_1 & F_2 & \dots \\ F_0^* & F_{-1} & F_{-2} & \dots \\ Z_0 & Z_1 & Z_2 & \dots \end{bmatrix}$$

EPG: Matrix formulation

- RF pulses
 - invert state (e.g., F_3 to F_{-3}) or can transfer between F and Z states
 - Simple pre-multiplication $P' = RP$, where R is

$$\begin{pmatrix} \cos^2 \frac{\alpha}{2} & e^{2i\phi} \sin^2 \frac{\alpha}{2} & -ie^{i\phi} \sin \alpha \\ e^{-2i\phi} \sin^2 \frac{\alpha}{2} & \cos^2 \frac{\alpha}{2} & ie^{-i\phi} \sin \alpha \\ -\frac{i}{2} e^{-i\phi} \sin \alpha & \frac{i}{2} e^{i\phi} \sin \alpha & \cos \alpha \end{pmatrix}$$

for an RF pulse with flip angle α and phase ϕ

EPG: Matrix formulation

- Gradients (in discretized units)
 - Increase number of states by 1
 - Replace all F_k states with F_{k-1} (e.g., F_0 becomes F_1)
 - Replace F_0 using F_0^*
 - Do not change Z states

The diagram shows the matrix P with three rows and four columns. The first row contains F_0 , F_1 , F_2 , and 0 . The second row contains F_0^* , F_{-1} , F_{-2} , and 0 . The third row contains Z_0 , Z_1 , Z_2 , and 0 . A green arrow points from F_0 to F_1 to F_2 . An orange arrow points from F_1 to F_0^* to F_{-1} to F_{-2} . A blue arrow points from F_0^* to F_0 . A white double-headed arrow is positioned below the matrix, spanning the width of the first three columns.

$$P = \begin{bmatrix} F_0 & F_1 & F_2 & 0 \\ F_0^* & F_{-1} & F_{-2} & 0 \\ Z_0 & Z_1 & Z_2 & 0 \end{bmatrix}$$

phase states grow linearly w.r.t. TSE ETL

EPG: Matrix formulation

- Relaxation
 - Transverse:
All F states attenuated by $E_2 = \exp(-T/T_2)$
 - Longitudinal:
All Z states attenuated by $E_1 = \exp(-T/T_1)$
 Z_0 state only has recovery of $M_0(1-E_1)$

EPG: Extensions

- Non-ideal slice profiles
- Variable RF flip angle and phase
- Motion / flow effects
- Diffusion effects
 - Weigel M, et al., JMR 2010; 205: 276-285

EPG Simulation

- Phase state propagation
 - RF pulse
 - T_1, T_2 decay
 - free precession
 - gradient pulse

EPG Simulation

Phase states:

$$P = \begin{bmatrix} F_0 & F_1 & F_2 & \dots \\ F_0^* & F_{-1} & F_{-2} & \dots \\ Z_0 & Z_1 & Z_2 & \dots \end{bmatrix}$$

RF pulse (θ, ϕ) , $P^+ = RP$:

$$R_{\{\theta, \phi\}} = \begin{bmatrix} \cos^2 \frac{\theta}{2} & e^{2i\phi} \sin^2 \frac{\theta}{2} & -ie^{i\phi} \sin \theta \\ e^{-2i\phi} \sin^2 \frac{\theta}{2} & \cos^2 \frac{\theta}{2} & ie^{-i\phi} \sin \theta \\ -\frac{i}{2} e^{-i\phi} \sin \theta & \frac{i}{2} e^{i\phi} \sin \theta & \cos \theta \end{bmatrix}$$

EPG Simulation

Gradients:

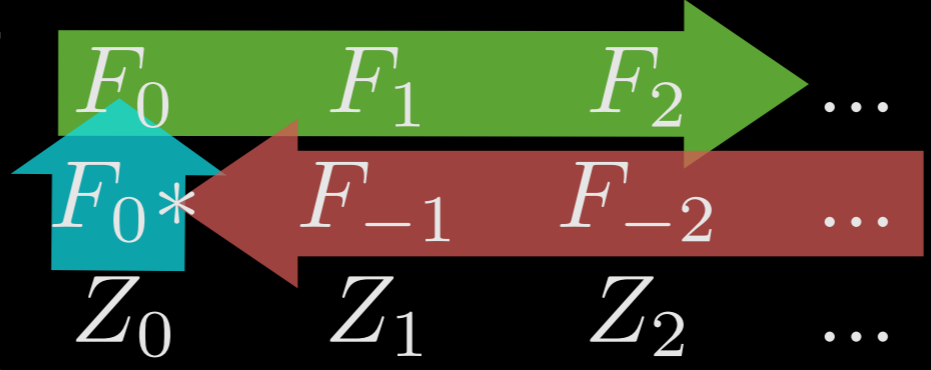
$$P = \begin{bmatrix} F_0 & F_1 & F_2 & \dots \\ F_0^* & F_{-1} & F_{-2} & \dots \\ Z_0 & Z_1 & Z_2 & \dots \end{bmatrix}$$

Relaxation:

$$F_k \rightarrow E_2 F_k$$

$$Z_k \rightarrow E_1 Z_k \quad (k > 0)$$

$$Z_0 \rightarrow E_1 Z_0 + M_0(1 - E_1)$$

EPG Simulation

- Transient state; steady state
- Different seq/tissue params

- Brian's MATLAB EPG sim code
 - will be emailed to class mailing list

EPG Simulation

- Example: Turbo Spin Echo
 - epg_rf.m
 - epg_grelax.m, epg_grad.m, epg_mgrad.m
 - epg_cpmg_hhw.m
 - EPGSim_CPMG_hhw.m
- can look at different refocusing RF trains

EPG Simulations: TSE

- non-CPMG 180s: $90x-180x-180x-\dots$
- CPMG 180s: $90x-180y-180y-\dots$
- non-CPMG 120s: $90x-120x-120x-\dots$
- CPMG 120s: $90x-120y-120y-\dots$
- CPMG 120s +prep: $90x-150y-120y-\dots$

EPG Simulations: TSE

non-CPMG 180s

CPMG 180s

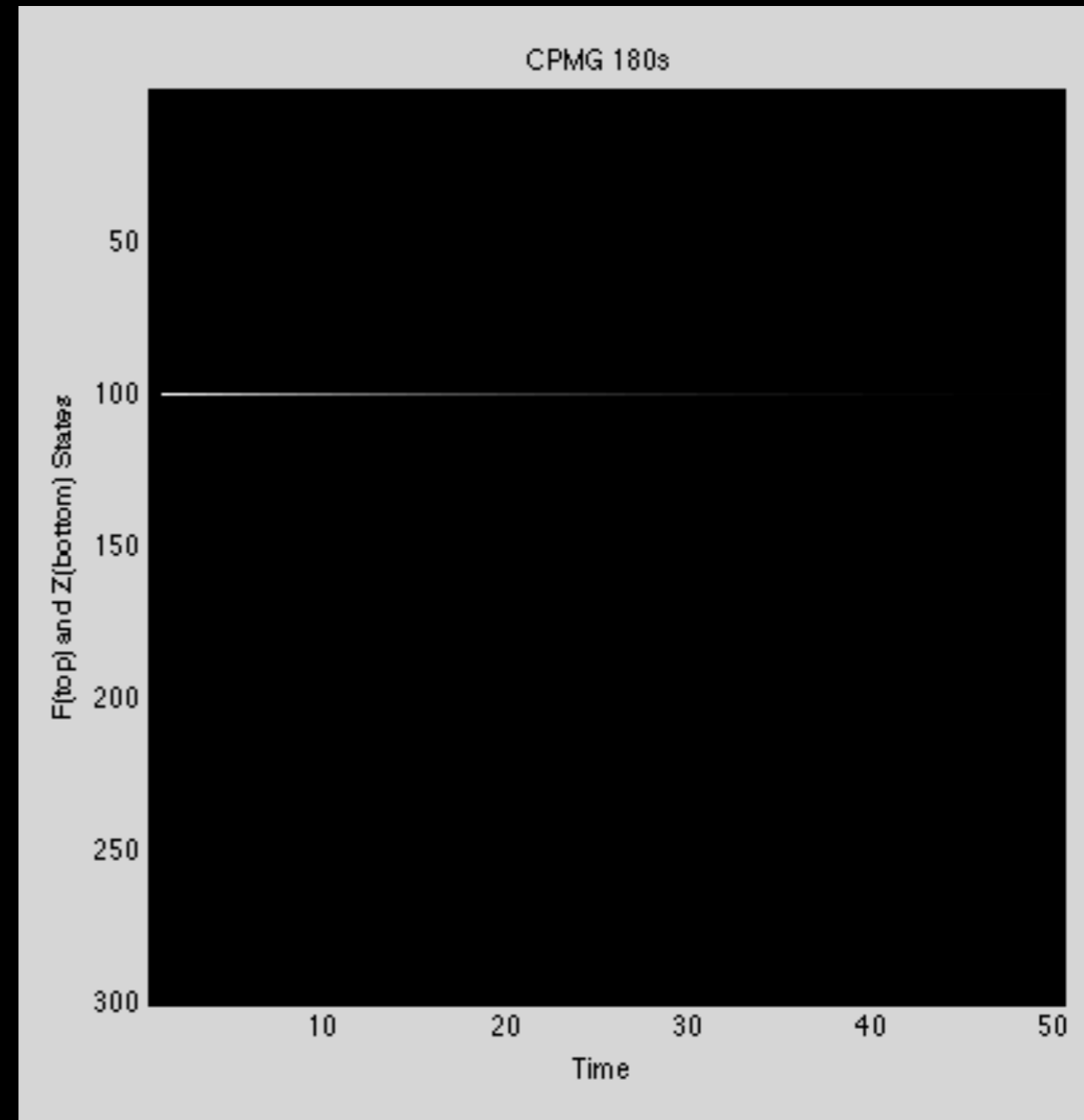
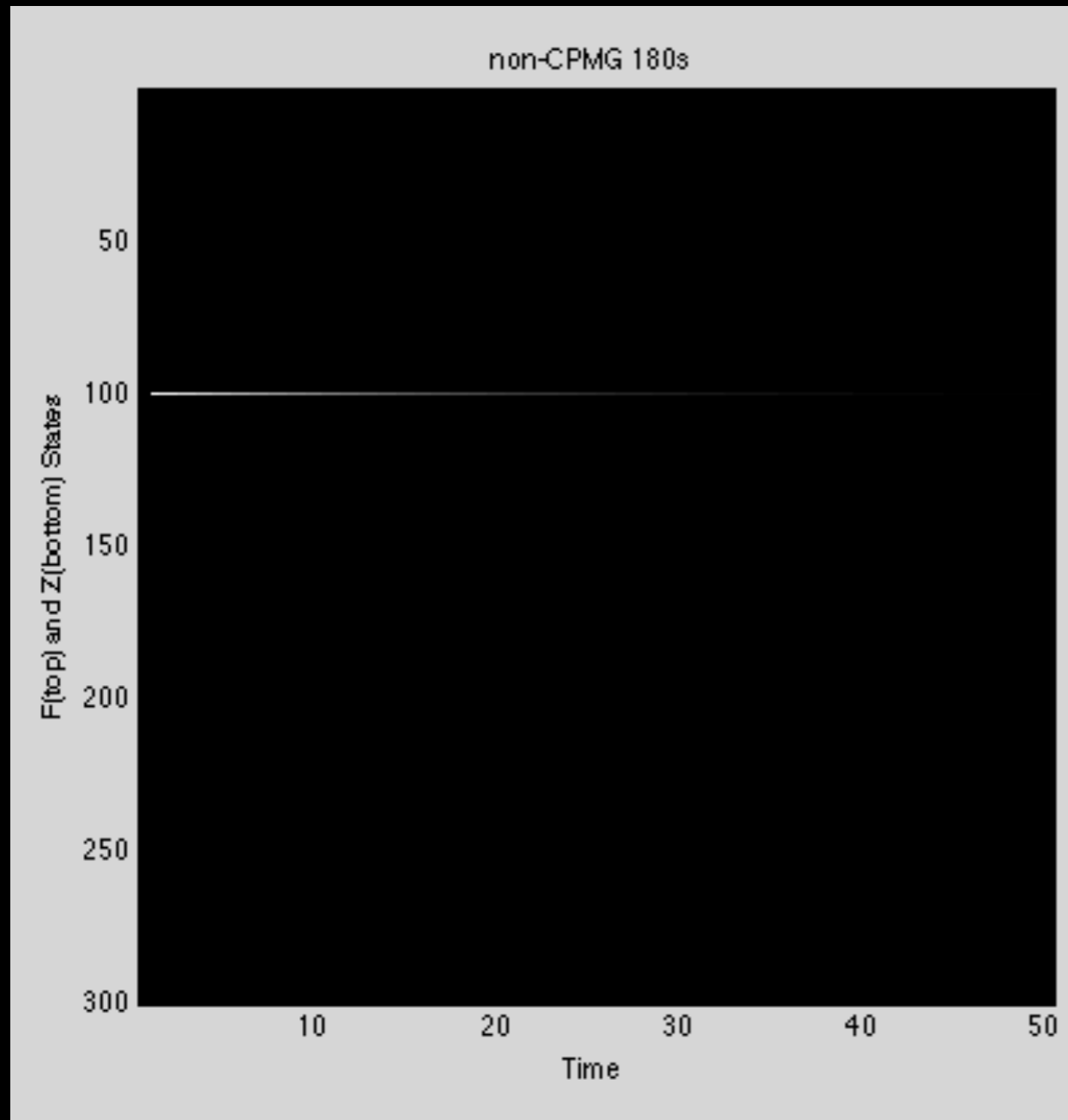

$T_1 = 1000$ ms, $T_2 = 100$ ms, ETL = 50, ESP = 10 ms

EPG Simulations: TSE

non-CPMG 120s

CPMG 120s

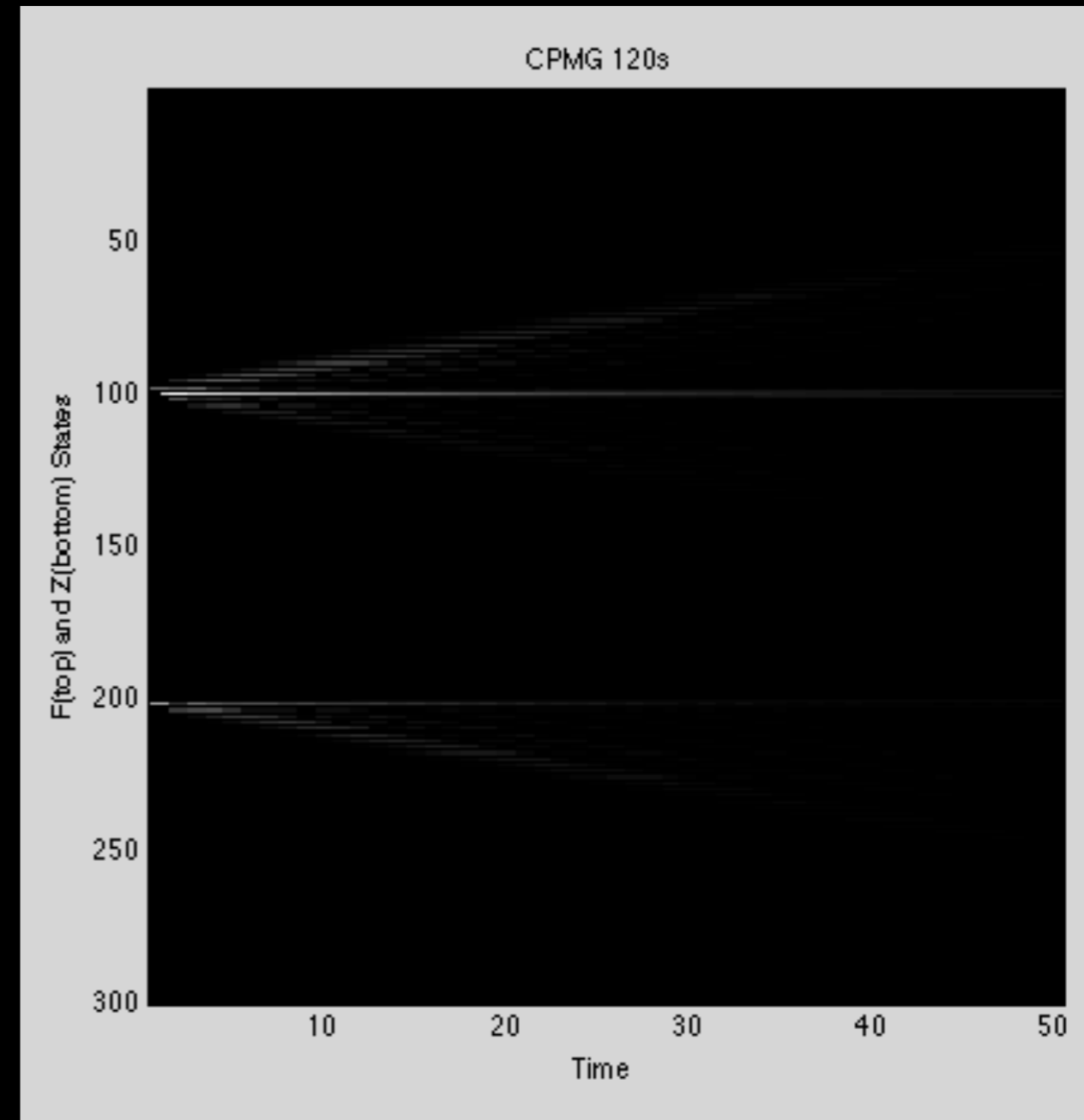
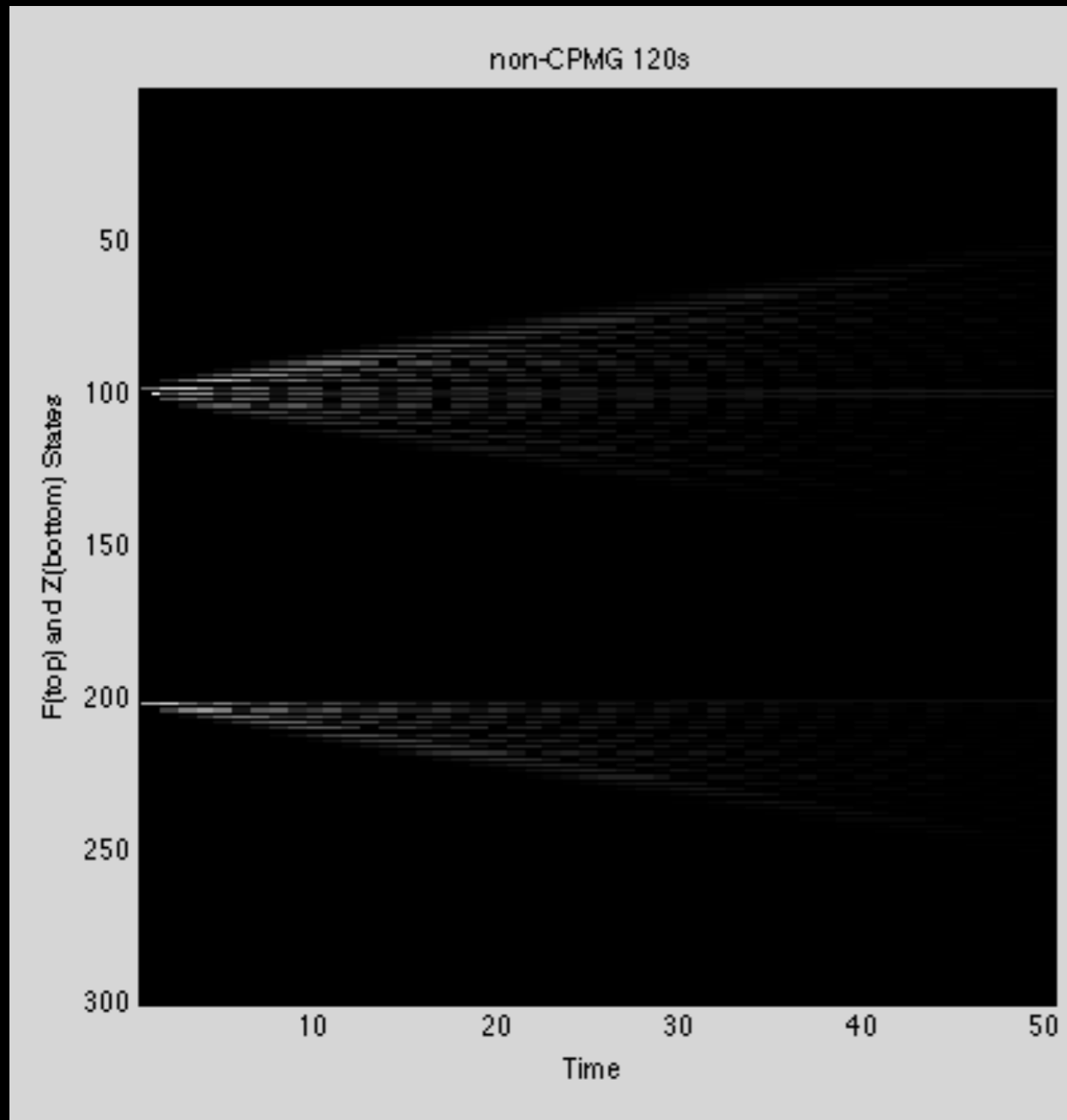

$T_1 = 1000$ ms, $T_2 = 100$ ms, ETL = 50, ESP = 10 ms

EPG Simulations: TSE

F_0 vs. echo number

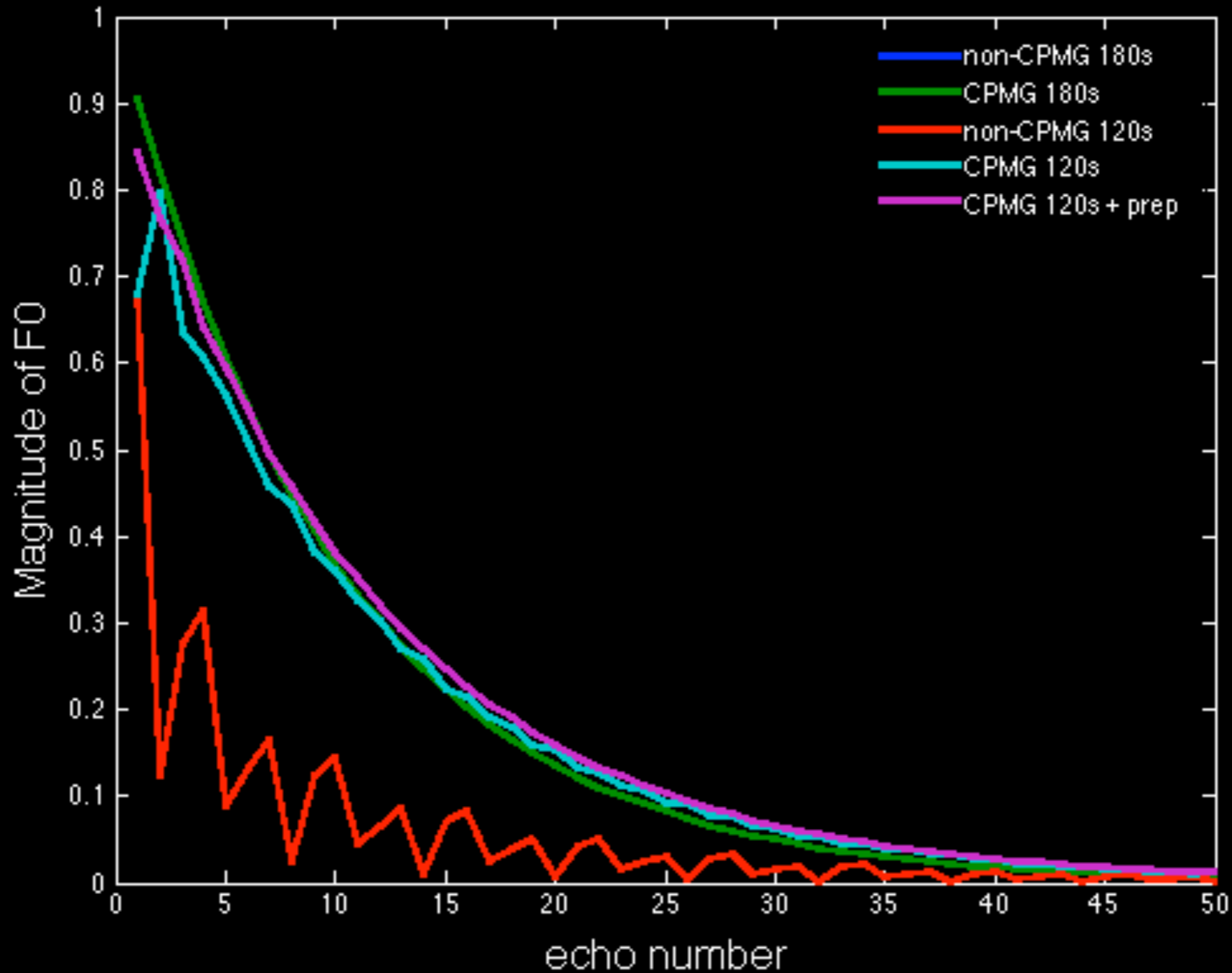

$T_1 = 1000$ ms, $T_2 = 100$ ms, ETL = 50, ESP = 10 ms

EPG Simulation

- Homework 1, part 2A
 - Gradient-spoiled GRE (SSFP-FID)

EPG Simulation

- Homework 1, part 2B
 - RF-spoiled GRE

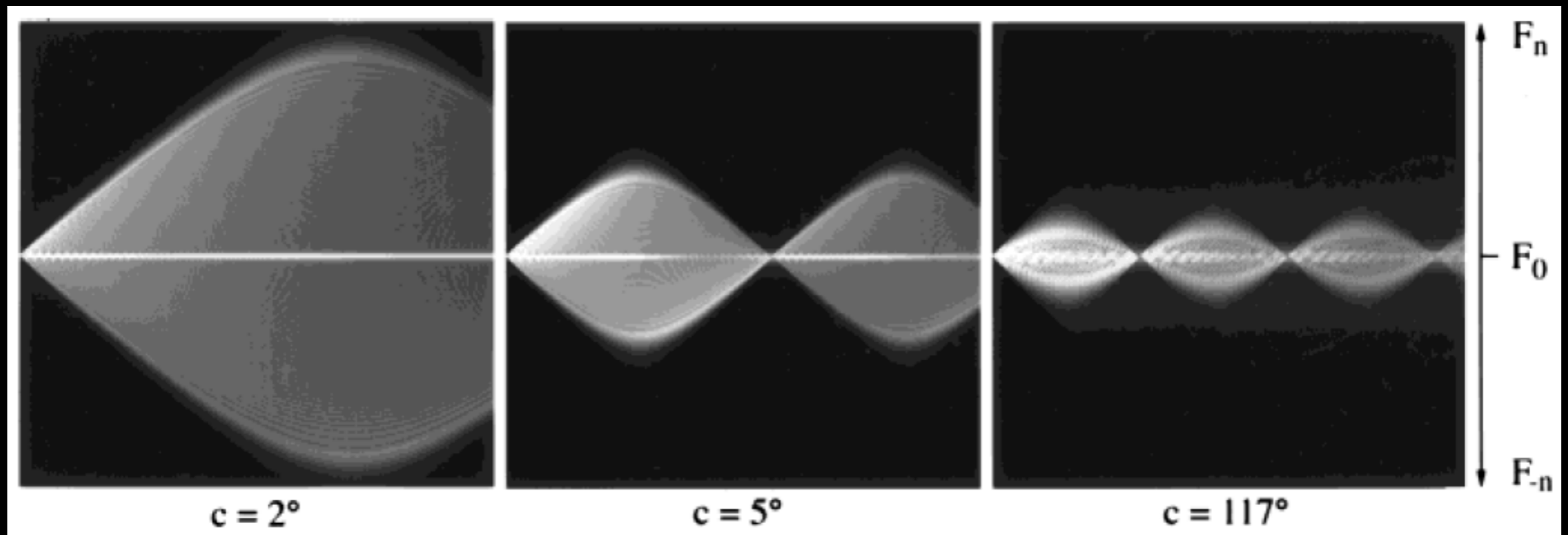

Homework 1

- Pulse Sequence Simulations
 - 1. Bloch: Steady state comparison, bSSFP transient state and catalyzation
 - 2. EPG: SSFP-FID, RF-spoiled GRE
- Due 5 pm, Fri, 4/24 by email
 - PDF and MATLAB code

Summary

- Multiple RF pulses -> multiple echoes
- EPG analysis
 - consider groups of spins
 - explicit treatment of pathways and echoes
 - flexible and powerful
 - you can do it!

Spin Bench

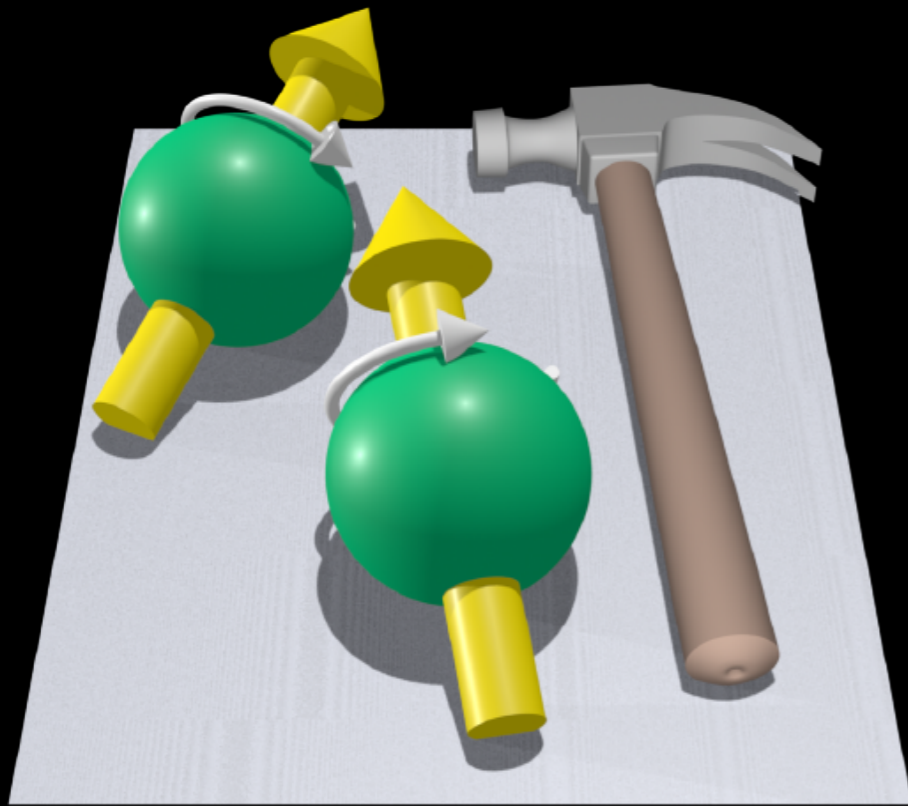

<https://www.heartvista.ai/spinbench>

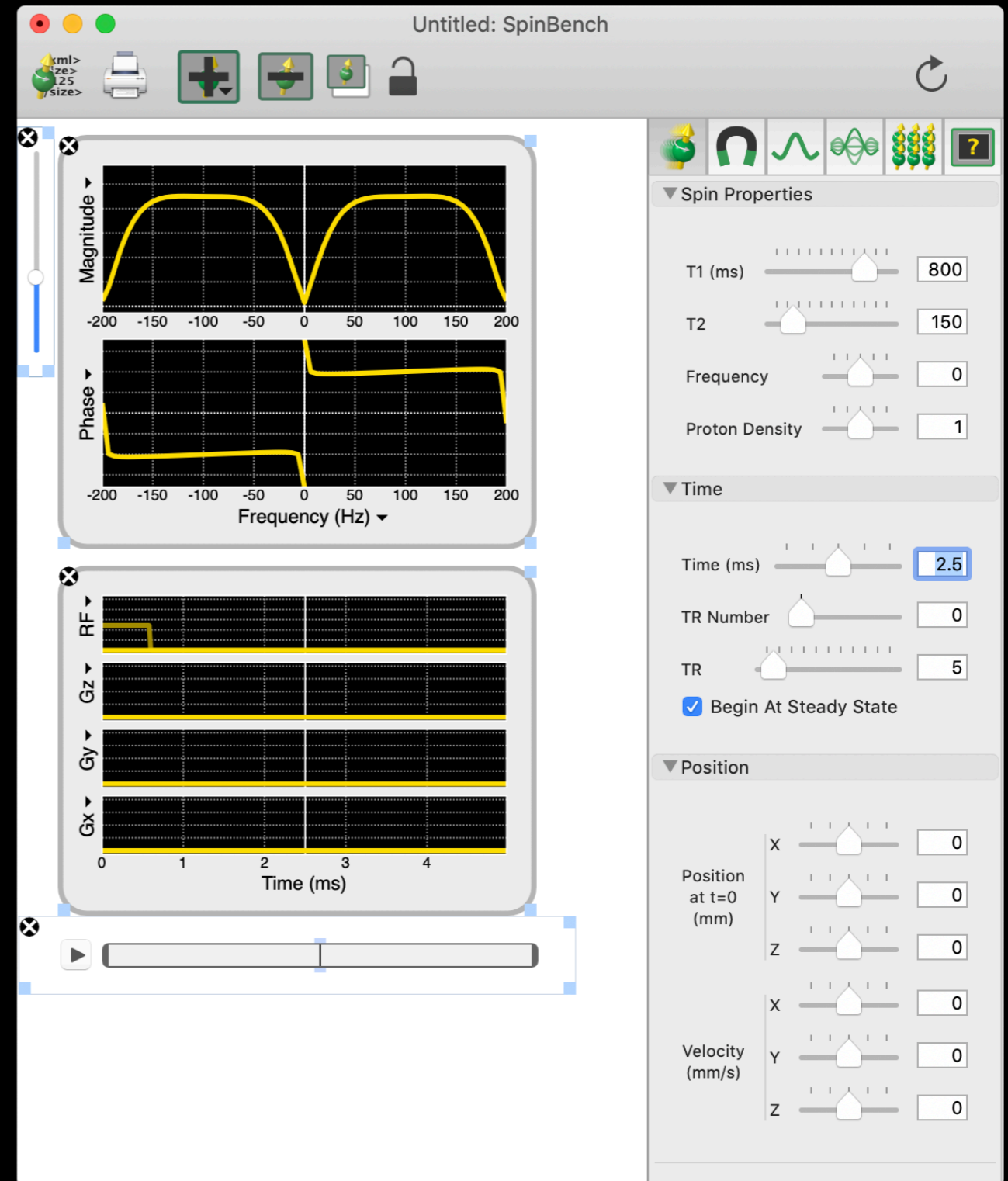

Thanks!

- Web resources
 - ISMRM 2010 Edu: Miller, Weigel
 - ISMRM 2011 Edu: Miller, Weigel
- Further reading
 - Bernstein et al., Handbook of MRI Sequences
 - Haacke et al., Magnetic Resonance Imaging
 - Scheffler, Concepts in MR 1999; 11:291-304
 - Hennig, JMR 1988; 78:397-407
 - Weigel, JMRI 2015; 41:266-295

Thanks!

- Acknowledgments
 - Brian Hargreaves's EPG slides and code
 - Kyung Sung's EPG slides
 - Isabel Dregely's EPG slides

Holden H. Wu, Ph.D.

HoldenWu@mednet.ucla.edu

<http://mrrl.ucla.edu/wulab>