

# *Deep Learning MRI Reconstruction*

M229 Advanced Topics in MRI

Shu-Fu Shih

5/18/2023

# Deep learning

- Deep learning is subset of machine learning, which is essentially a neural network with many layers.
- Deep learning network “learns” from a lot of data to perform a variety of tasks in computer vision, natural language processing, bioinformatics...
- The success of deep learning since 2010s
  - Availability of large public datasets
  - Accessibility of GPUs for parallel computing
  - Accessibility of codes and toolboxes for deep neural network training

# Deep learning MRI reconstruction

- It's impossible to cover all aspects of deep learning for MRI reconstruction because it's an active and rapid-changing research field.
- In this lecture, we will focus on:
  - Introducing basic components of deep learning networks, especially on ConvNet
  - Providing some insights on why it *might* work
  - Presenting different applications of deep learning in MRI reconstruction

# Image reconstruction model

- General image acquisition model:  $y = Ax + n$ 
  - $y$ : the acquired data in the sensor domain (e.g., k-space in MRI)
  - $x$ : the image
  - $n$ : additive noise
  - $A$ : an operator which is modality dependent
    - For computed tomography (CT):  $A$  is Radon transform
    - For fully sampled Cartesian MRI:  $A$  is Fourier transform
    - For undersampled Cartesian MRI:  $A$  includes subsampling and Fourier transform
    - For non-Cartesian MRI:  $A$  is non-uniform Fourier transform

# Image reconstruction model

- To solve an underdetermined inverse problem (e.g., in the case of undersampled MRI), constrained reconstruction methods have been popular

Image model

$$y = Ax + n$$

Constrained reconstruction  
optimization problem

$$\operatorname{argmin}_x L(x) = F(Ax, y) + \lambda\Phi(W, x)$$

Consistency with  
sensor-domain data

Regularization term  
encoding prior information

# Image reconstruction model

- Deep learning uses information from a large dataset to learn a non-linear mapping.
- In the task for MRI reconstruction from undersampled data:

Non-linear neural network

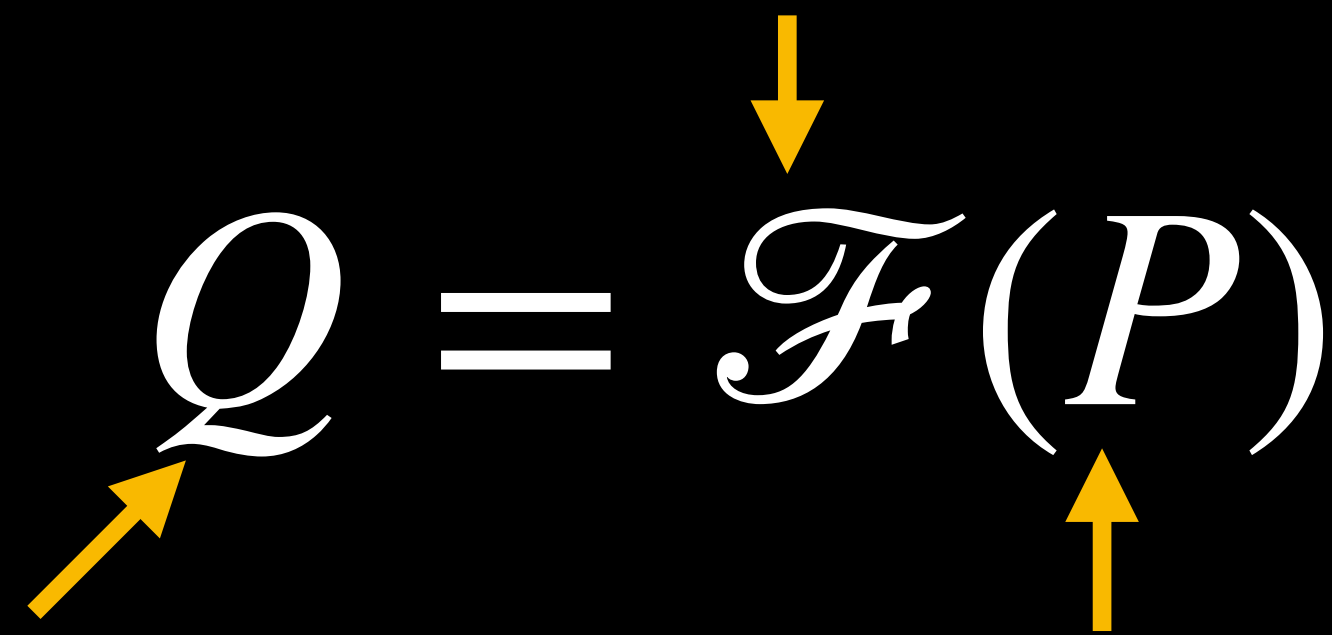
$$Q = \mathcal{F}(P)$$
The diagram shows the equation  $Q = \mathcal{F}(P)$  in white text. A yellow arrow points from the text 'Non-linear neural network' down to the function symbol  $\mathcal{F}$ . Another yellow arrow points from the text 'Images or k-space data from undersampled measurements' up to the variable  $P$ . A third yellow arrow points from the text 'Images with reduced artifacts or fully sampled images/k-space data' up to the variable  $Q$ .

Images with reduced artifacts or fully sampled images/k-space data

Images or k-space data from undersampled measurements

# Deep learning medical imaging reconstruction

- Different realizations:

Image-domain learning

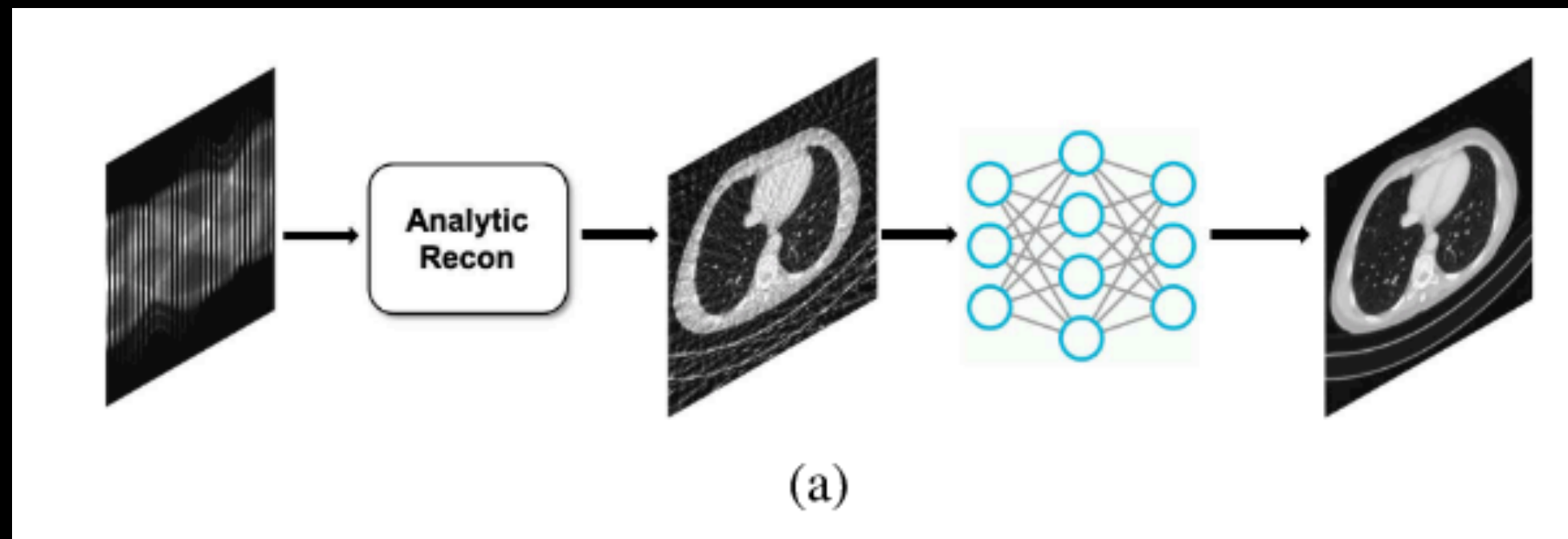

Hybrid-domain learning

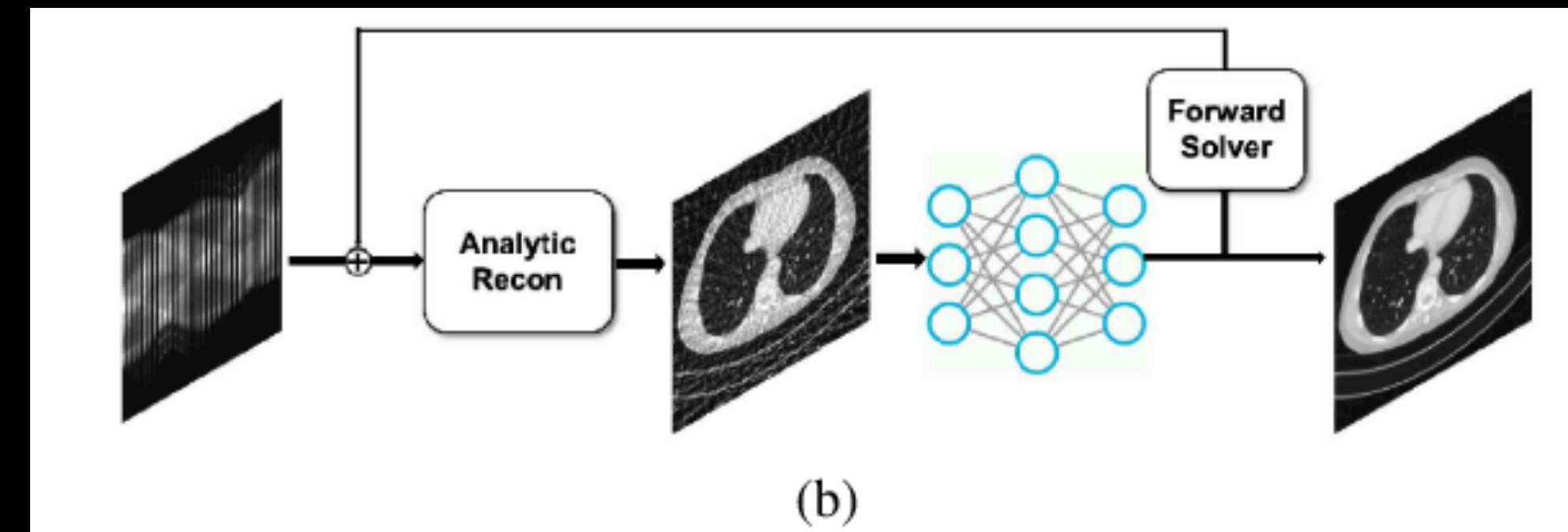

Mapping between sensor domain and image domain

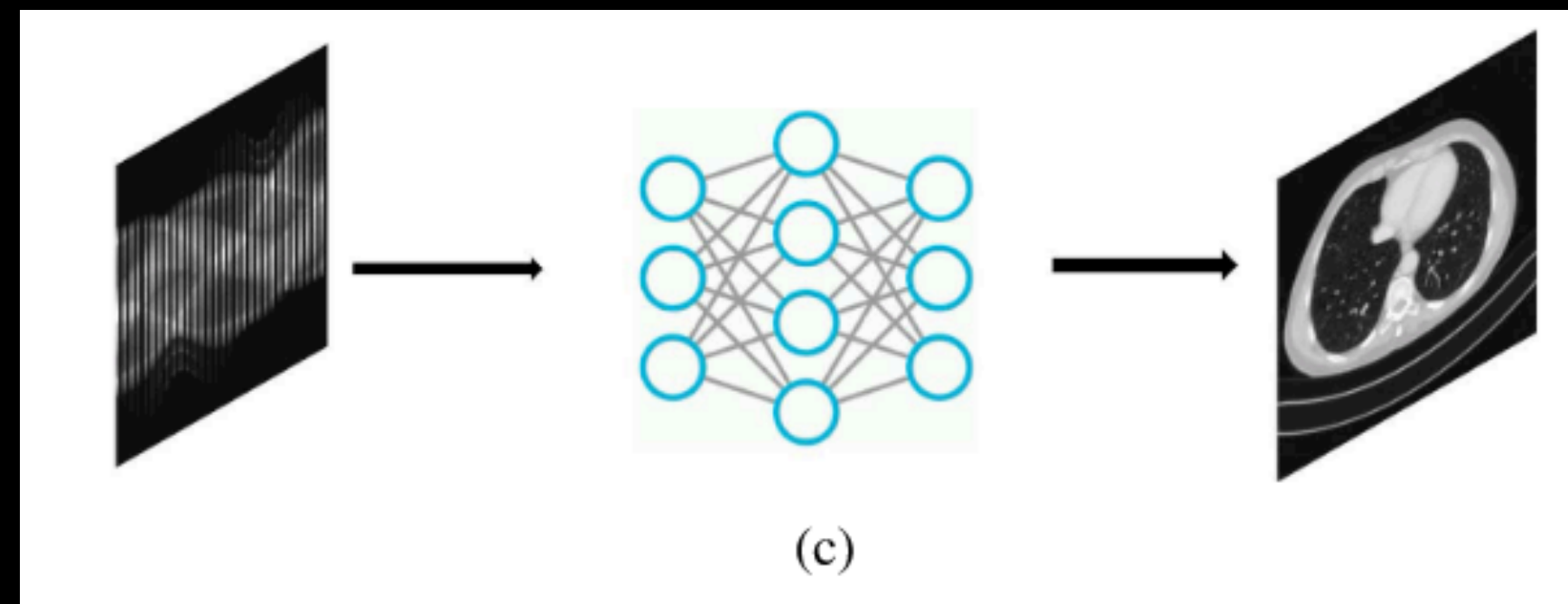

Sensor-domain learning

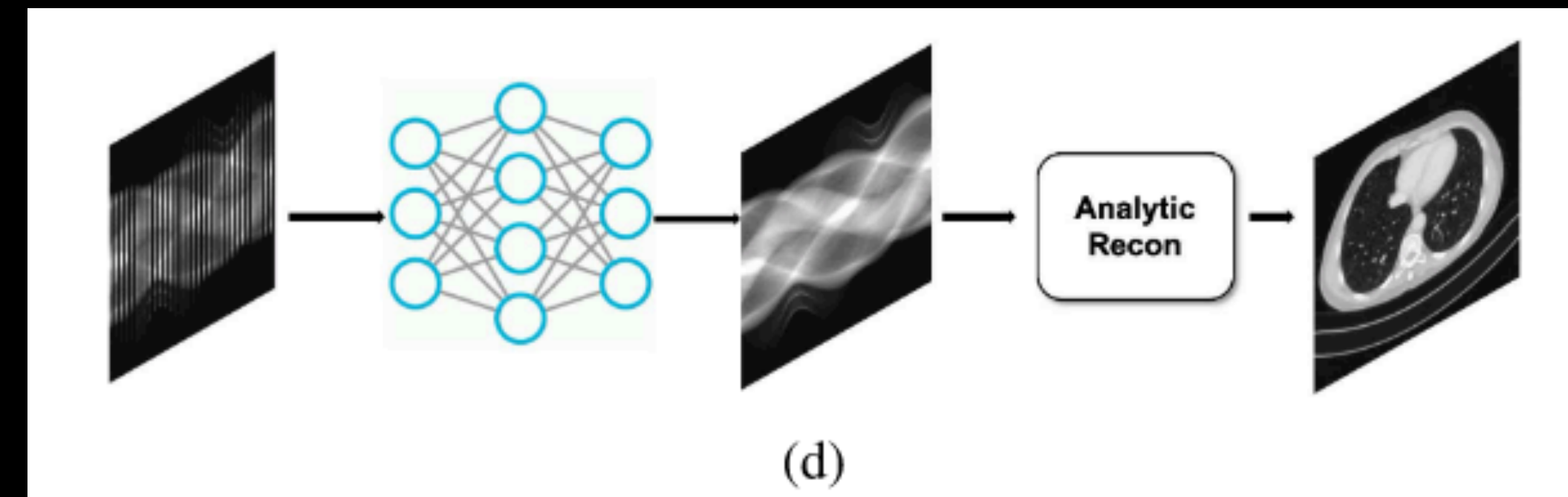

# Convolution Neural Networks (CNN or ConvNet)

- ConvNet is one of the most popular deep learning network for imaging tasks
- We will introduce several key components in ConvNet and show how it can be trained
  - Convolution layer
  - Pooling layer
  - Activation function
  - Loss function
  - Optimizer
  - Regularization
  - Batch normalization
  - ...



# Where it all started...

- LeNet-5<sup>1</sup>: one of the very first ConvNet architectures with back-propagation for handwritten digit recognition

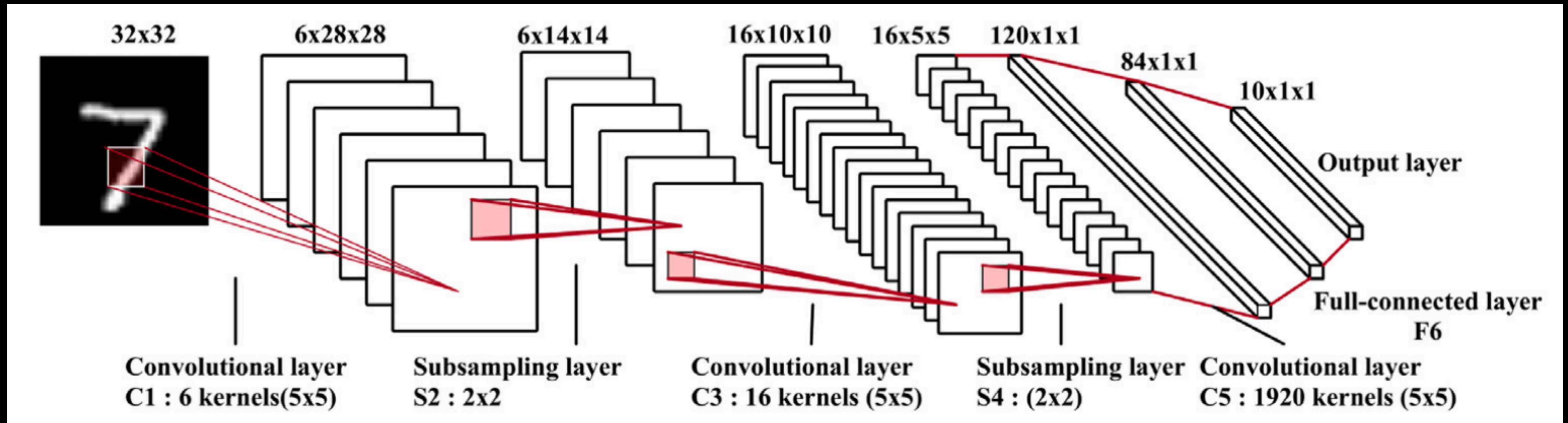

# A glimpse of popular ConvNet models

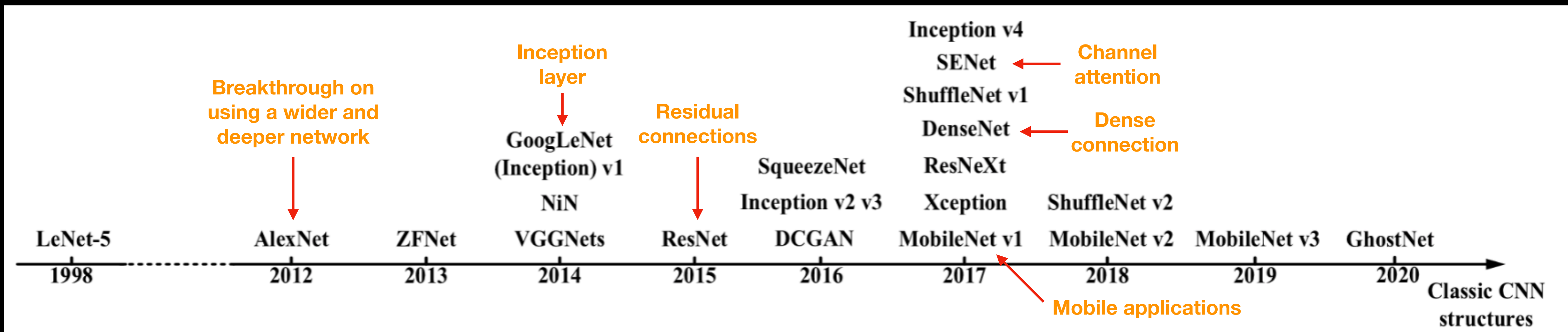

\* Many of these ConvNet were first used in natural images (not medical images) and in a variety of tasks (e.g., classification, segmentation...)

# Popular ConvNet: U-Net

- The original U-Net was designed for medical image segmentation.
- It has been modified and applied in many DL-based MRI reconstruction tasks.

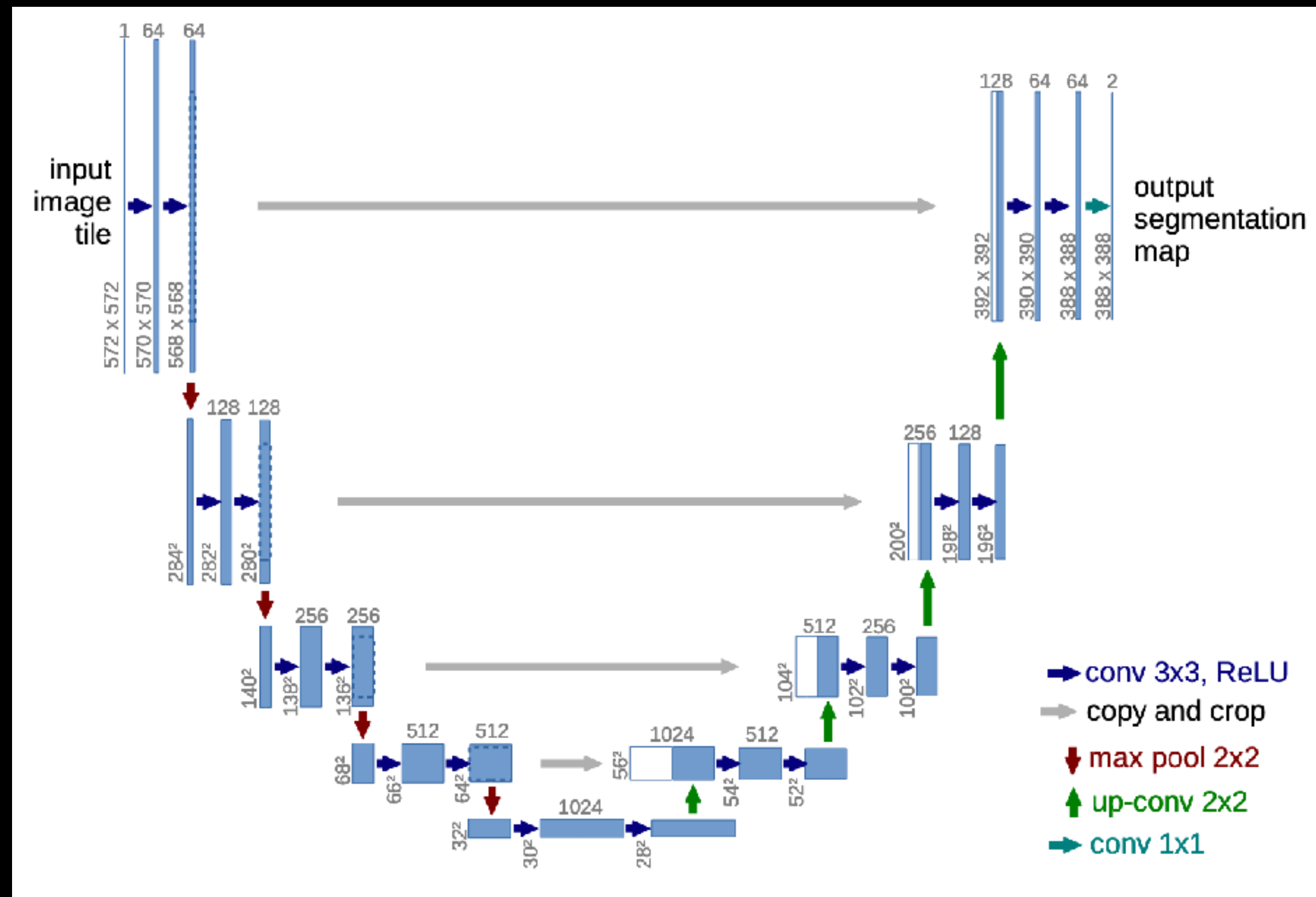

- Convolution at different levels
- Pooling layers
- Contracting and expansive paths
- Skipped connections

# Convolutional layer

- Convolution operation: use a shared kernel to convolve with the entire image

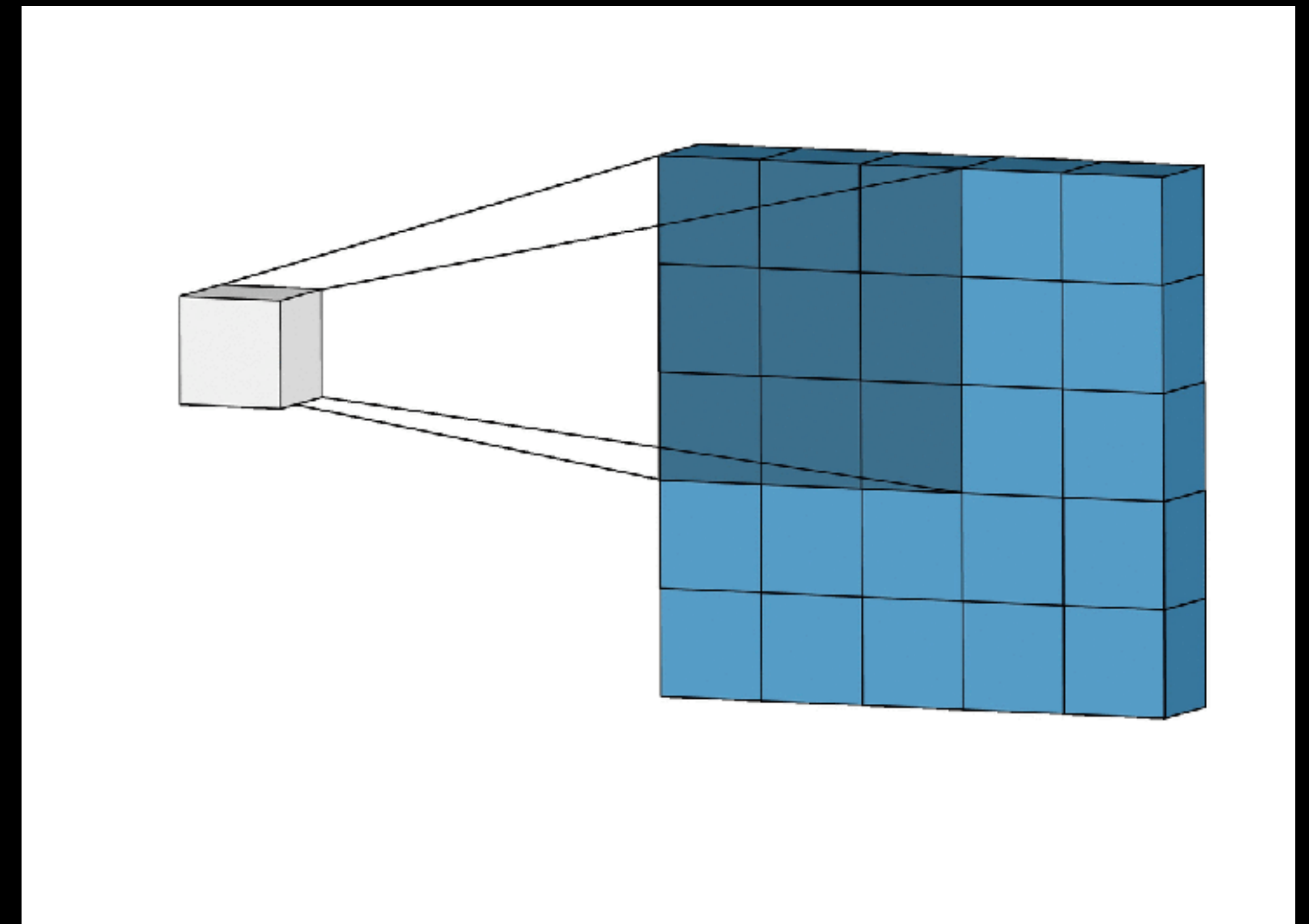
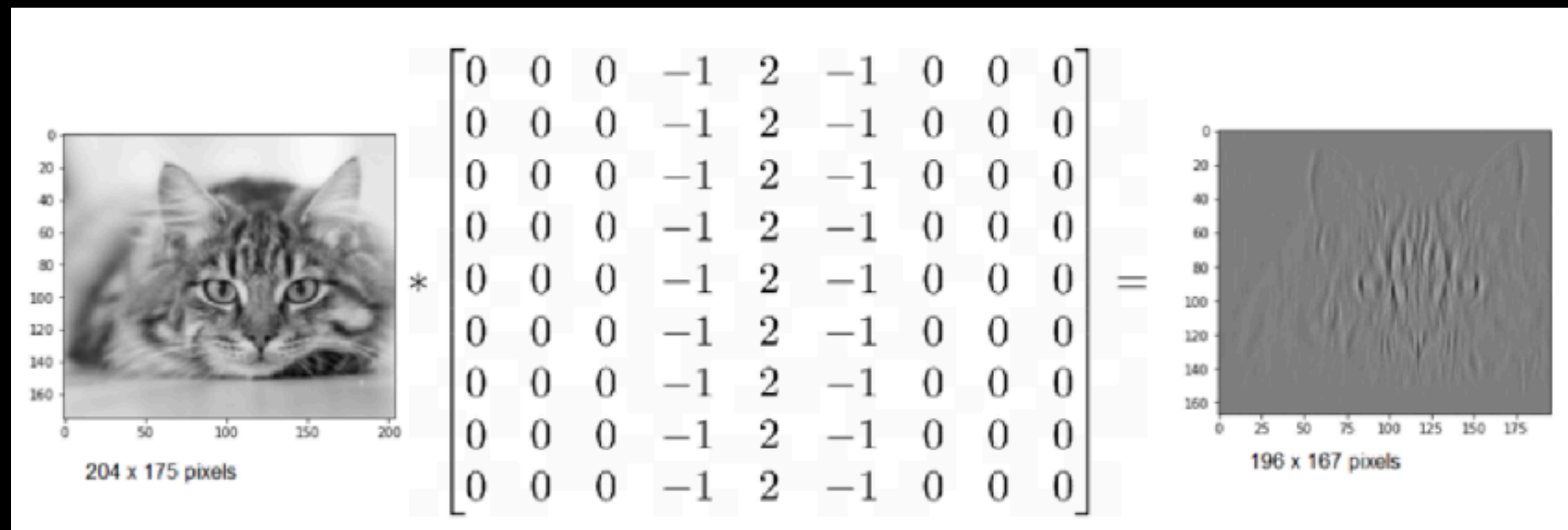
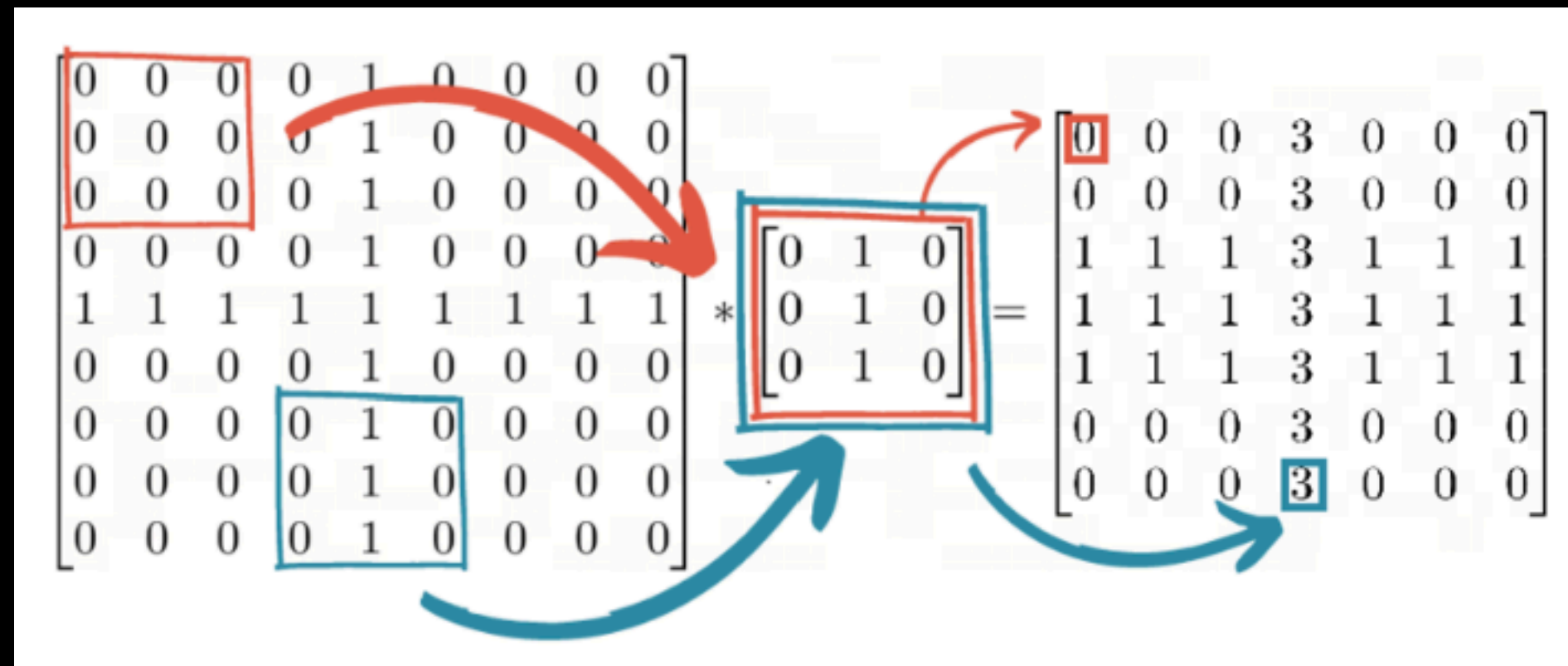

# Convolutional layer

- Motivation of using a convolutional layer
- (1) Sparse interaction
  - Each pixel interacts with the kernel instead of all the other pixels.
- (2) Translational invariance
  - Some features are shared across the entire image.
  - The features do not change if the input is shifted.

# Pooling layer

- Generate a summary of statistics with a reduced number of weights
  - Stride: the number of pixel shift for the next pooling operation

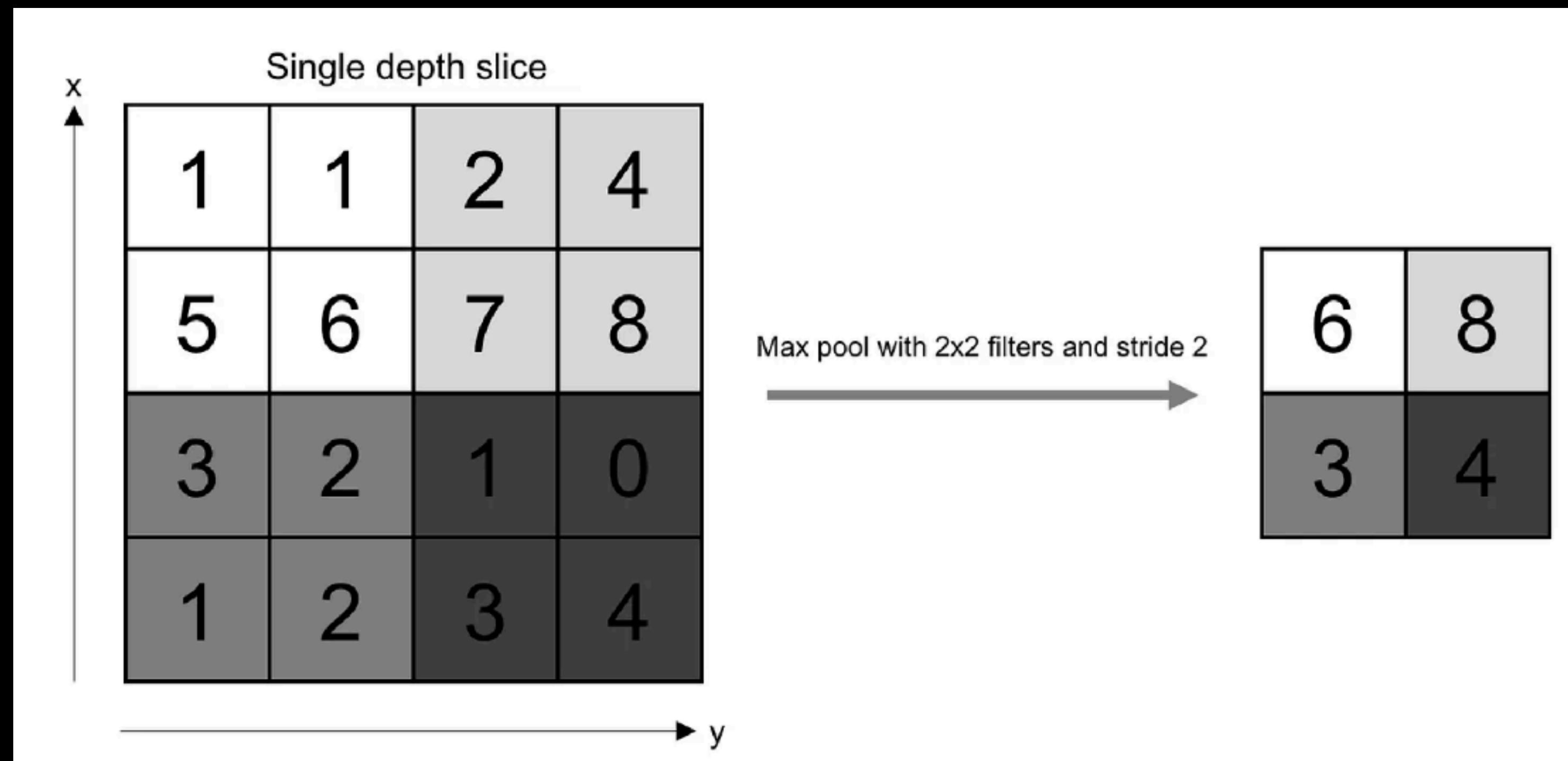

# Activation function

- Convolution operation is linear. A stack of convolutional layers only generates a linear mapping process.
- Activation functions are used to introduce non-linearity to the network.
- ReLU (rectified linear unit):  $f(a) = \max(0, a)$

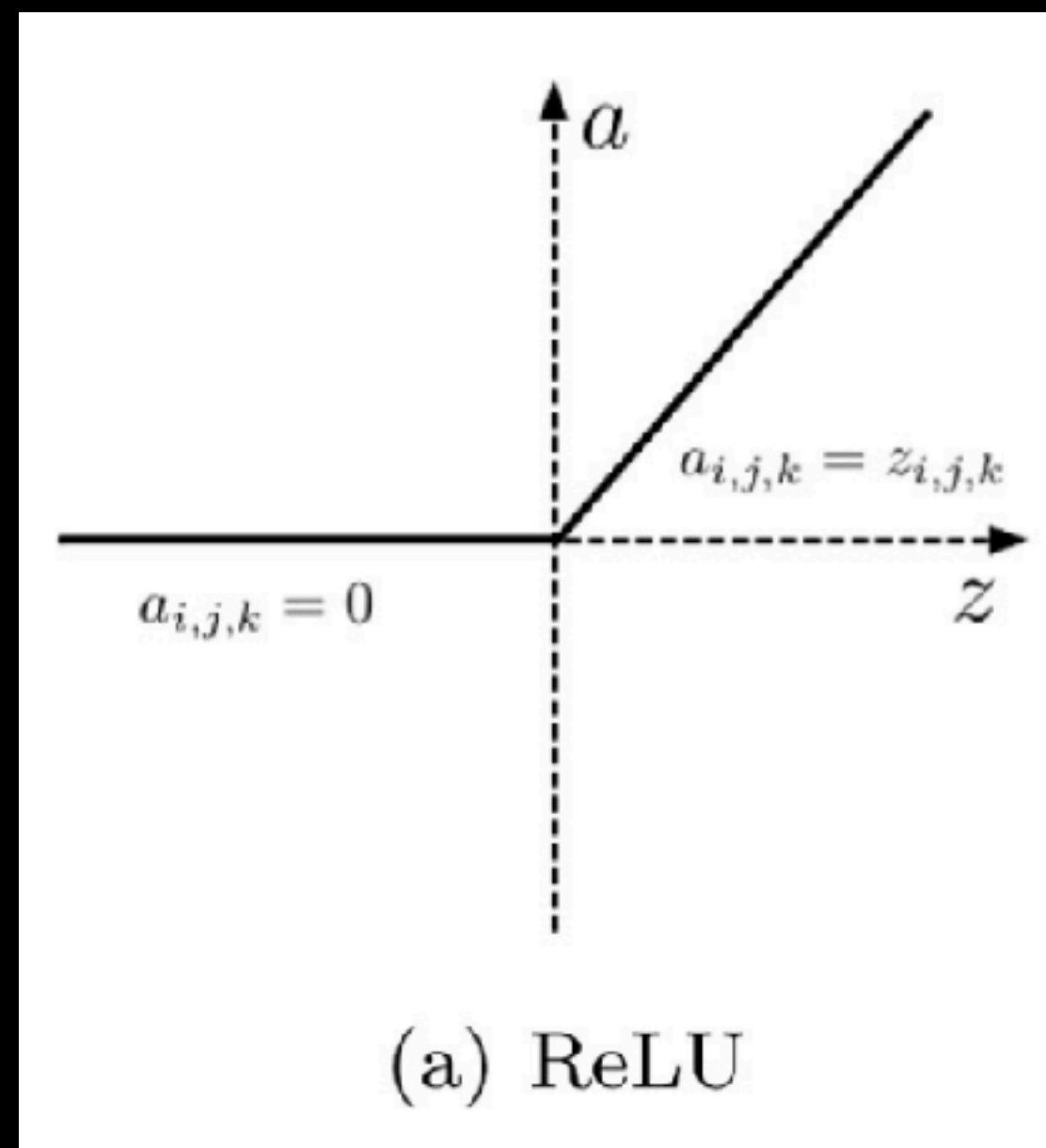

# Improvements on activation functions

- ReLU has zero gradient when the node is not active
  - Different activation functions have been proposed to alleviate the problem

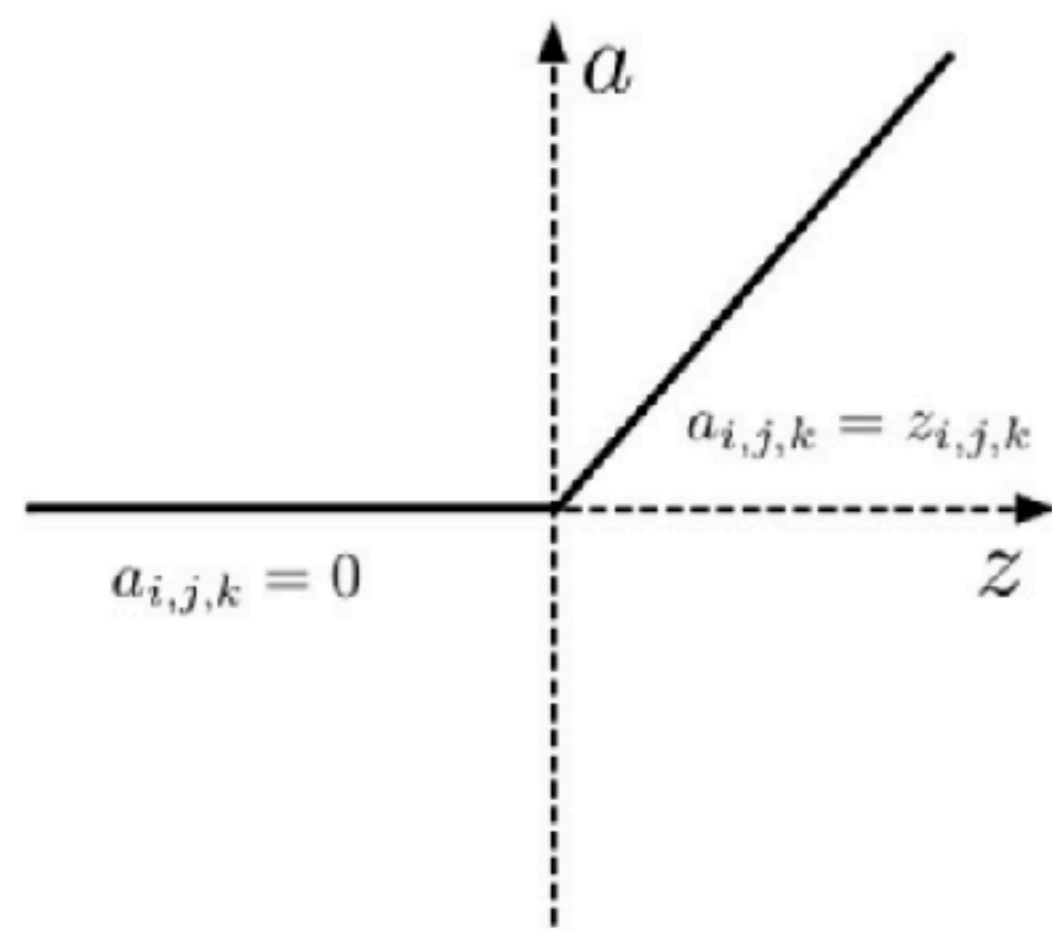

(a) ReLU

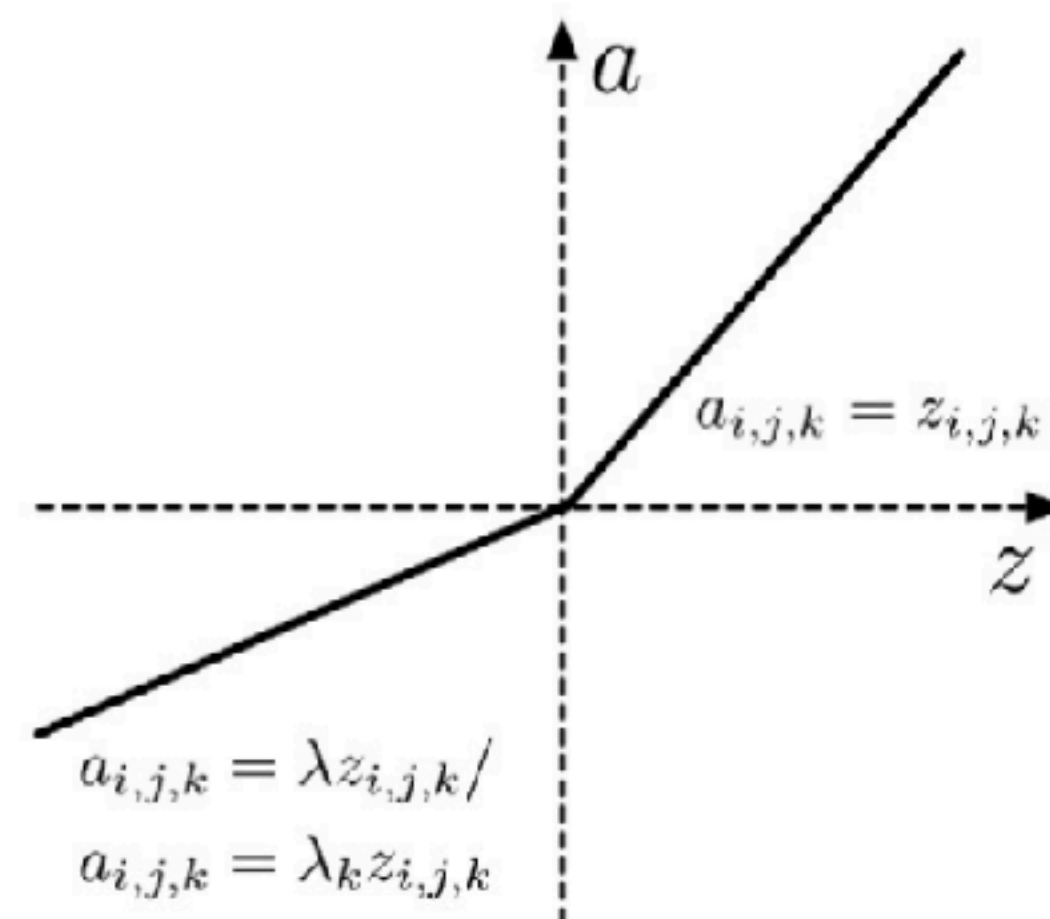

(b) LReLU/PReLU

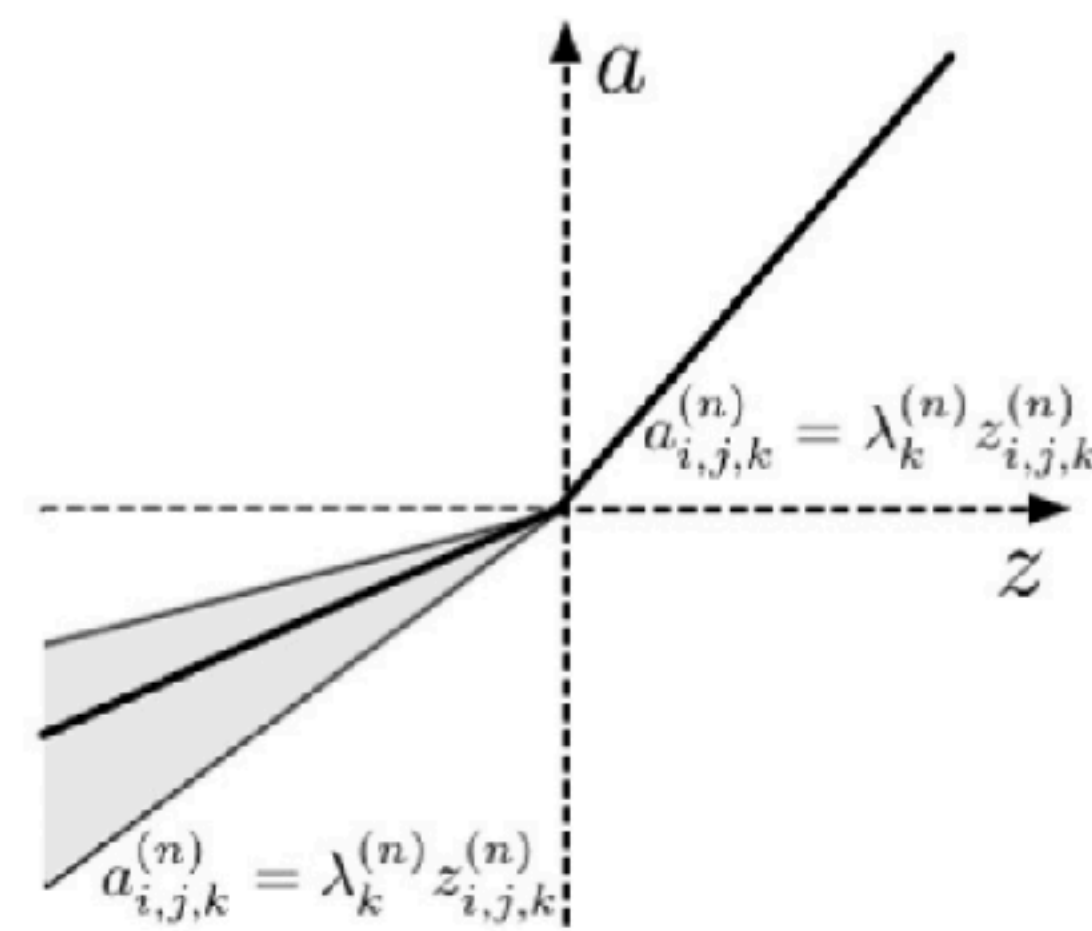

(c) RReLU

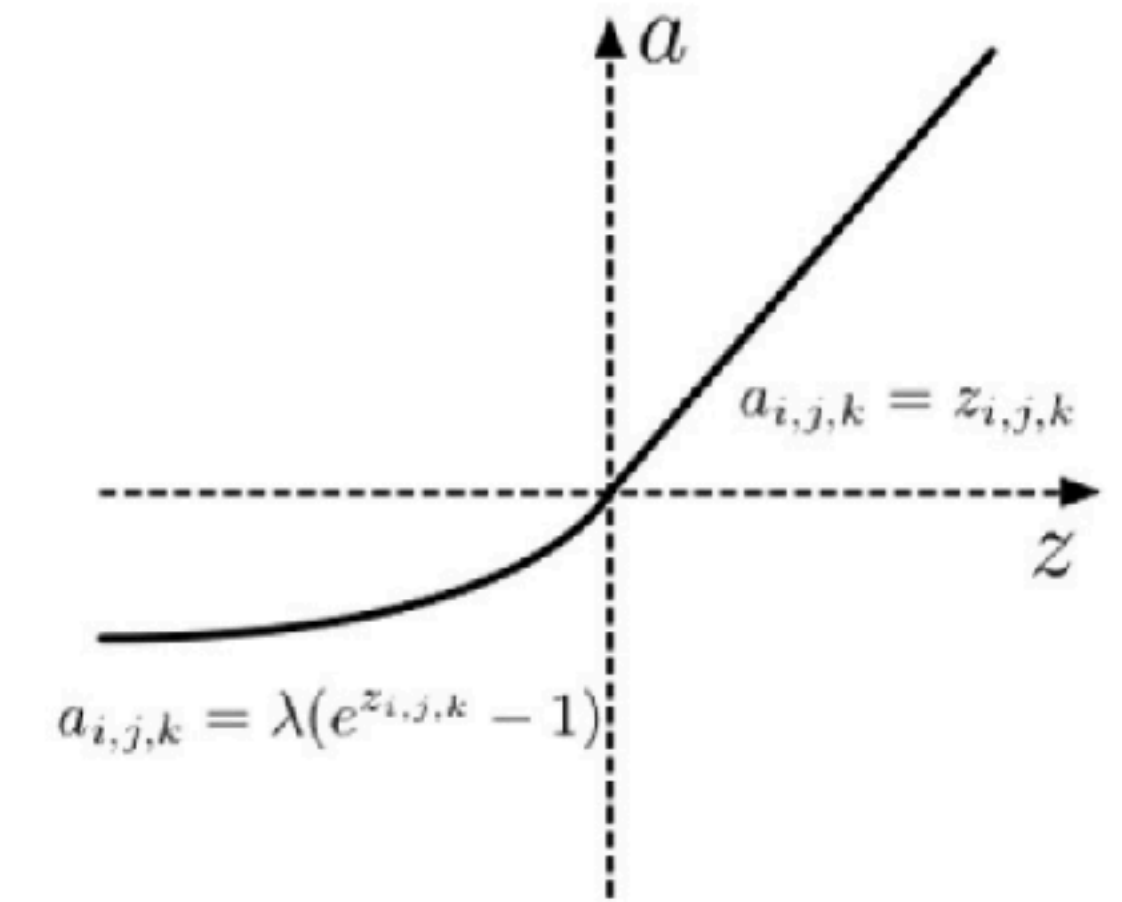

(d) ELU



# Loss function

- We need an objective criteria to tell the network how well it performs.
- The overall network is trained to minimize the loss function.
- Loss functions for image reconstruction:
  - MSE loss / L2 loss
  - L1 loss
  - SSIM (structural similarity index measure) loss
  - perceptual loss
  - GAN (generative adversarial network) loss
  - ...

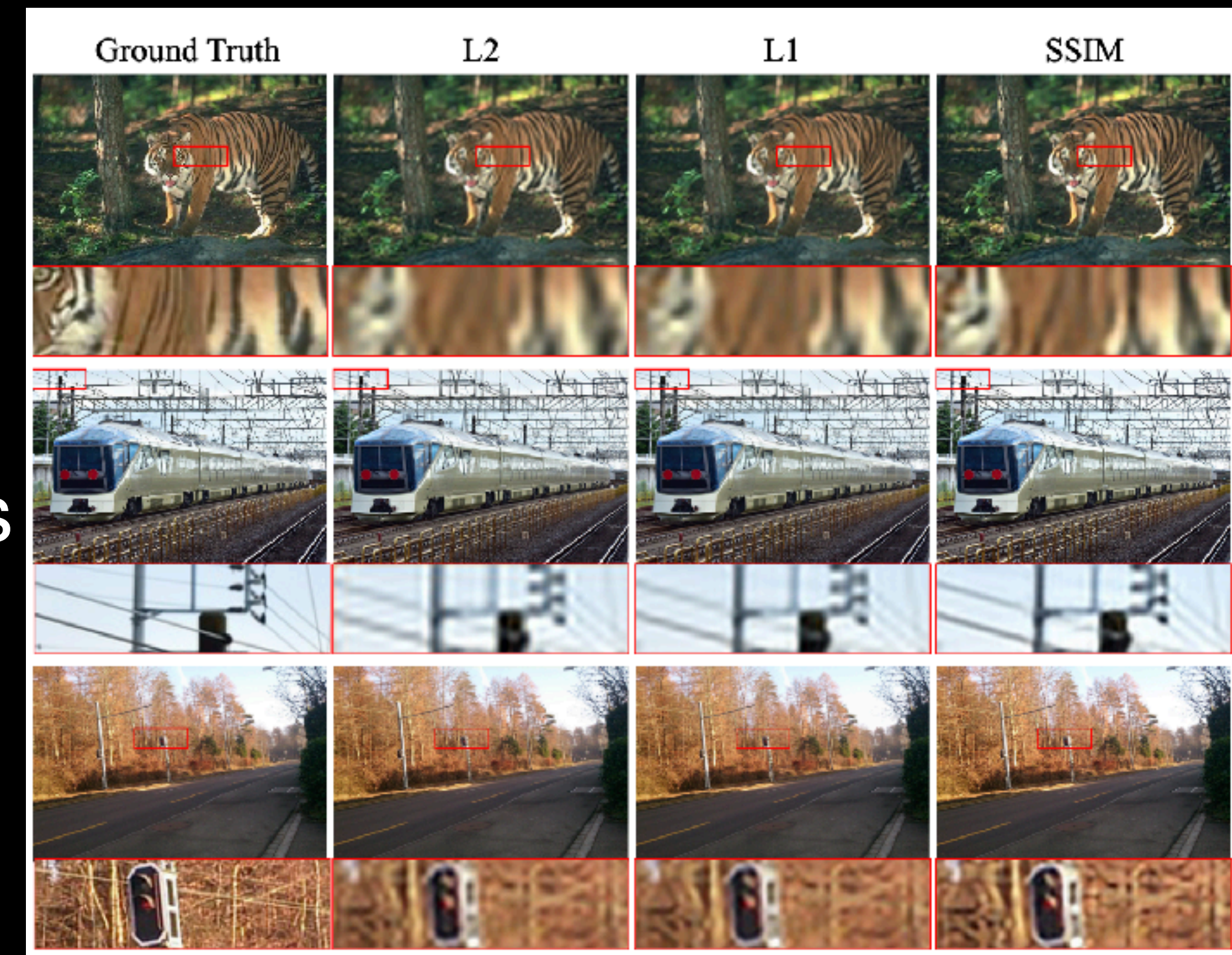

# Optimizer

- Algorithms used to update network parameters for loss minimization
  - Gradient descent
  - Stochastic gradient descent
    - Replace the actual gradient calculation from the entire dataset by using a randomly selected subset
    - “Batch size” can be used to refer to the number of training samples in one forward/backward pass

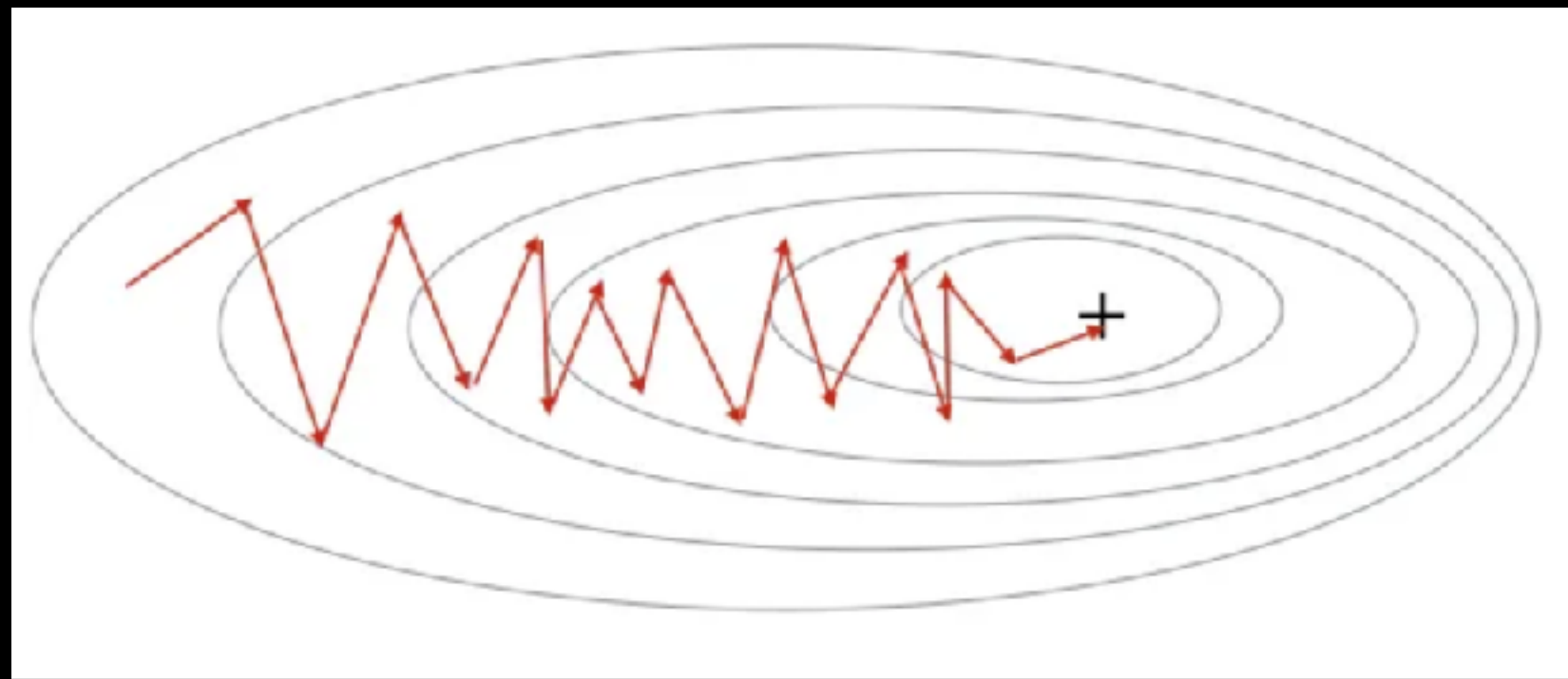

Stochastic gradient descent

# Optimizer

- To avoid local minimum problems, there are more adaptive optimizers that incorporate a “momentum” idea that use previous gradient information
  - Adagrad
  - RMSProp
  - Adam
  - ...

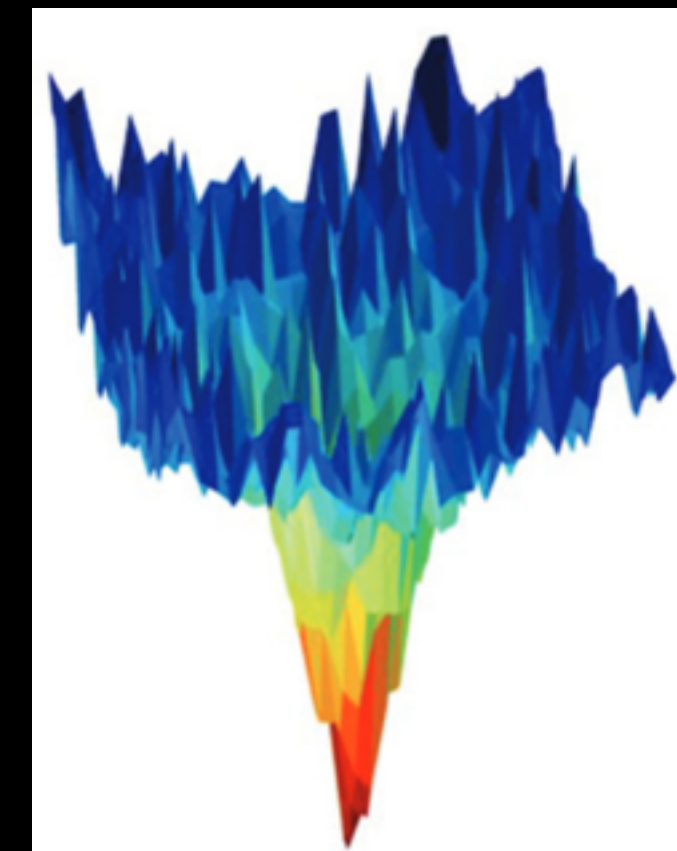
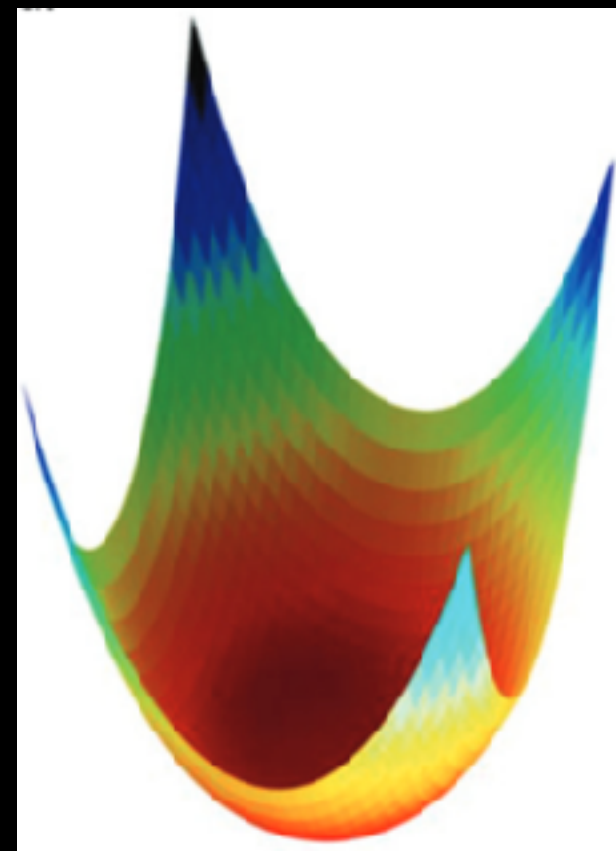

- Luckily, there are many optimizers already implemented in popular deep learning frameworks (PyTorch, TensorFlow...)

# Optimizer

- Find a suitable learning rate

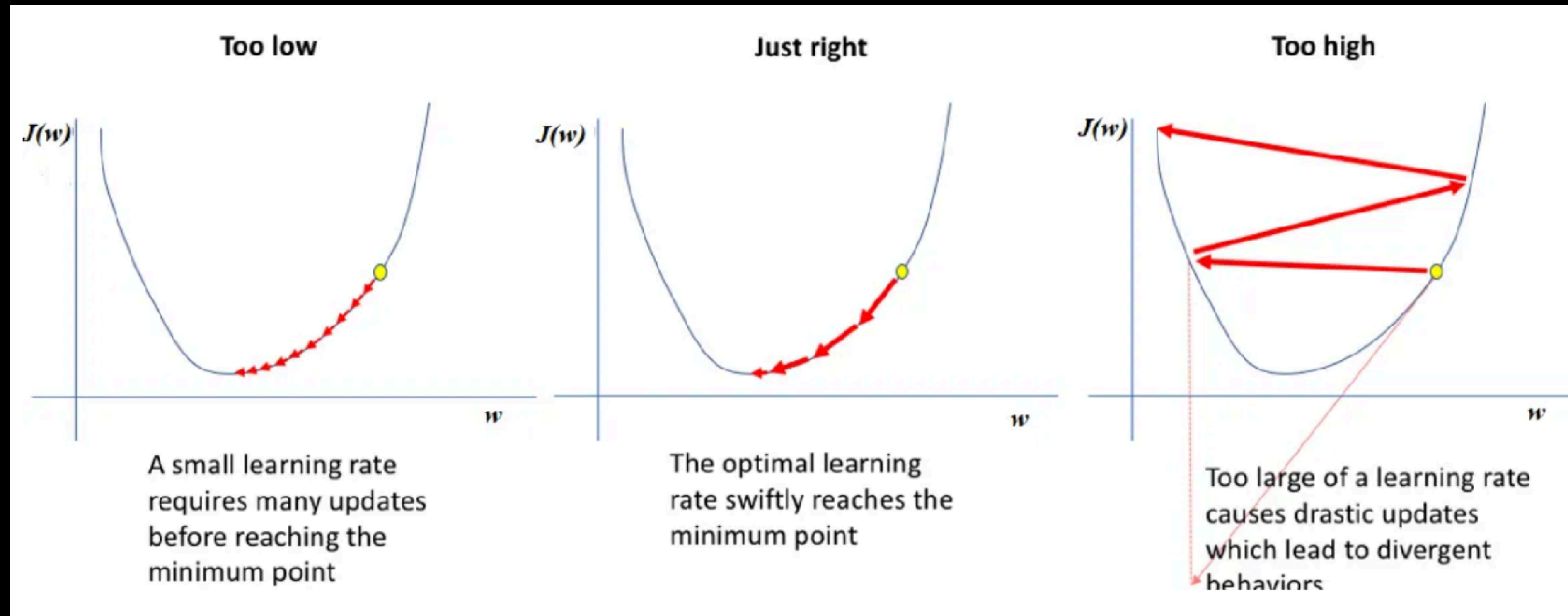

# Back-propagation

- Once we know about the gradient, back-propagation is usually used as an efficient way to update the network's trainable parameters.

# Back-propagation

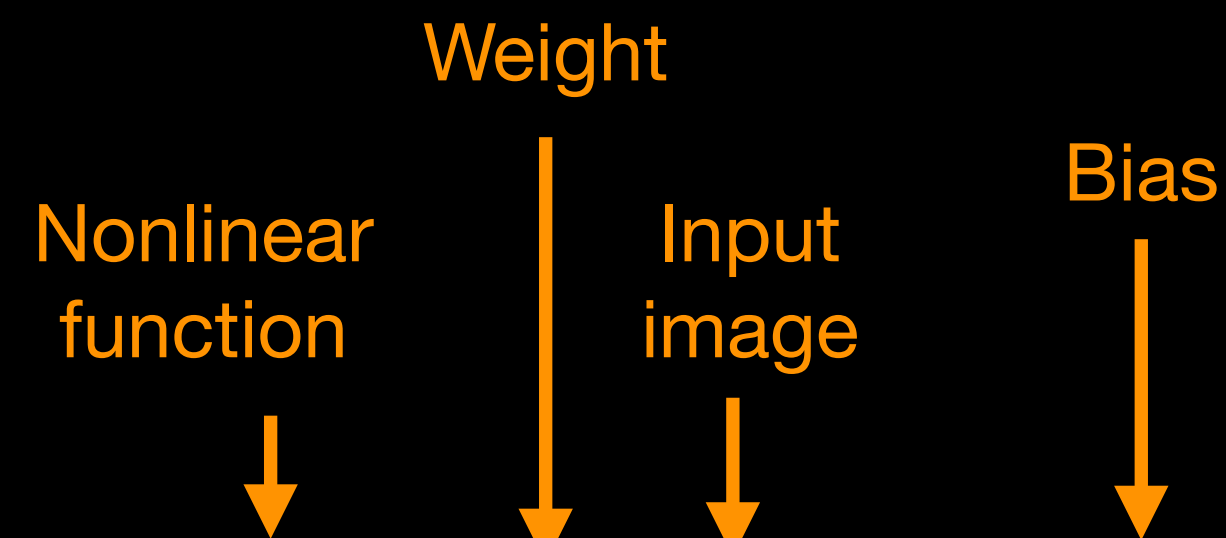

One layer:  $Q = \phi(wP + b)$

Network with deep layers:  $Q = \mathcal{F}(P) = \phi(w_n \dots \phi(w_2 \phi(w_1 P + b_1) + b_2) \dots + b_n)$

First layer  
Second layer

Using chain rule  
To calculate derivatives  $Q = \mathcal{F}(g(P)) \longrightarrow \frac{\partial Q}{\partial P} = \frac{\partial \mathcal{F}(P)}{\partial P} = \mathcal{F}'(g(x)) \cdot g'(x)$

- Luckily, back-propagation can be done easily using popular deep learning frameworks (PyTorch, TensorFlow...)

# Regularization

- Regularization is any modification we make to a learning algorithm that is intended to reduce its generalization error but not its training error<sup>1</sup>.
- Examples:
  - Include prior knowledge
  - Apply some constraints on the parameters in the loss function
  - Data augmentation: image flipping, rotation...
  - Dropout
  - ...

# Regularization

- Dropout<sup>1</sup>
  - Randomly “turn off” some of the weights during the training process.

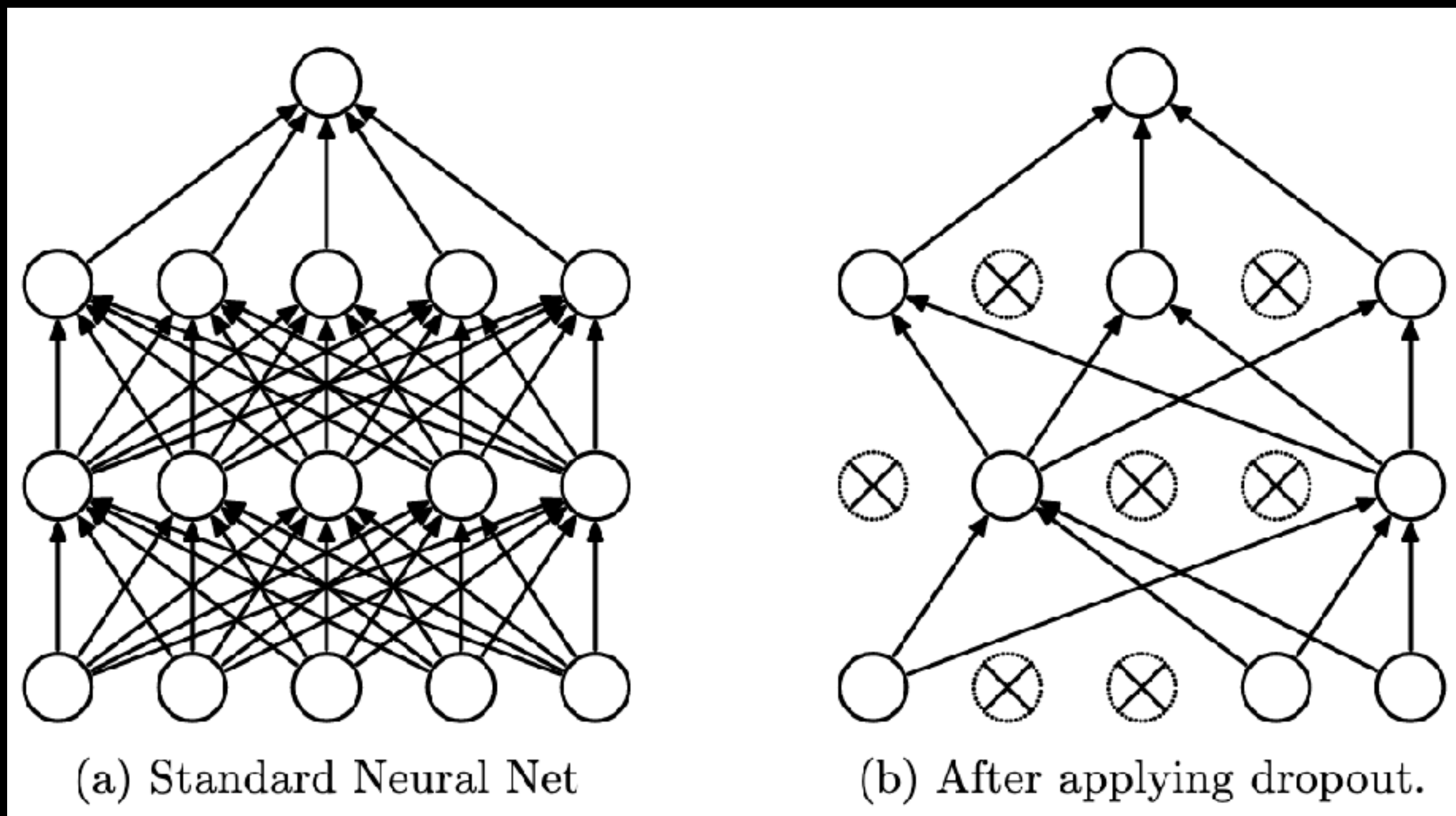



# Batch normalization

- Internal covariance shift<sup>1</sup>
  - The distribution of the inputs in each layer changes as learning occurs in previous layers.
- Batch normalization<sup>1</sup> normalizes output of the previous layer by subtracting the batch mean, and then dividing by the batch's standard deviation (i.e., normalizing the previous output)

# Data stratification

- A proper data stratification ensures that training and evaluation data is representative of the distributions in the population.
- Things to consider in MRI applications:
  - Subject demographics (sex, age,...)
  - Patients/Healthy volunteers
  - Different diseases
  - Sequence acquisition parameters
  - ...

# Validation

- Different validation methods
  - Train/test split
  - k-Fold cross validation
  - Leave-one-out cross validation
  - ...

# Validation

- k-fold cross validation



# Hyperparameter tuning

- There are many hyperparameters in deep learning networks
  - Learning rate
  - Batch size
  - Architecture design: number of layers, numbers of channels
  - ...
- Approaches for hyperparameter tuning
  - Grid search
  - Random search

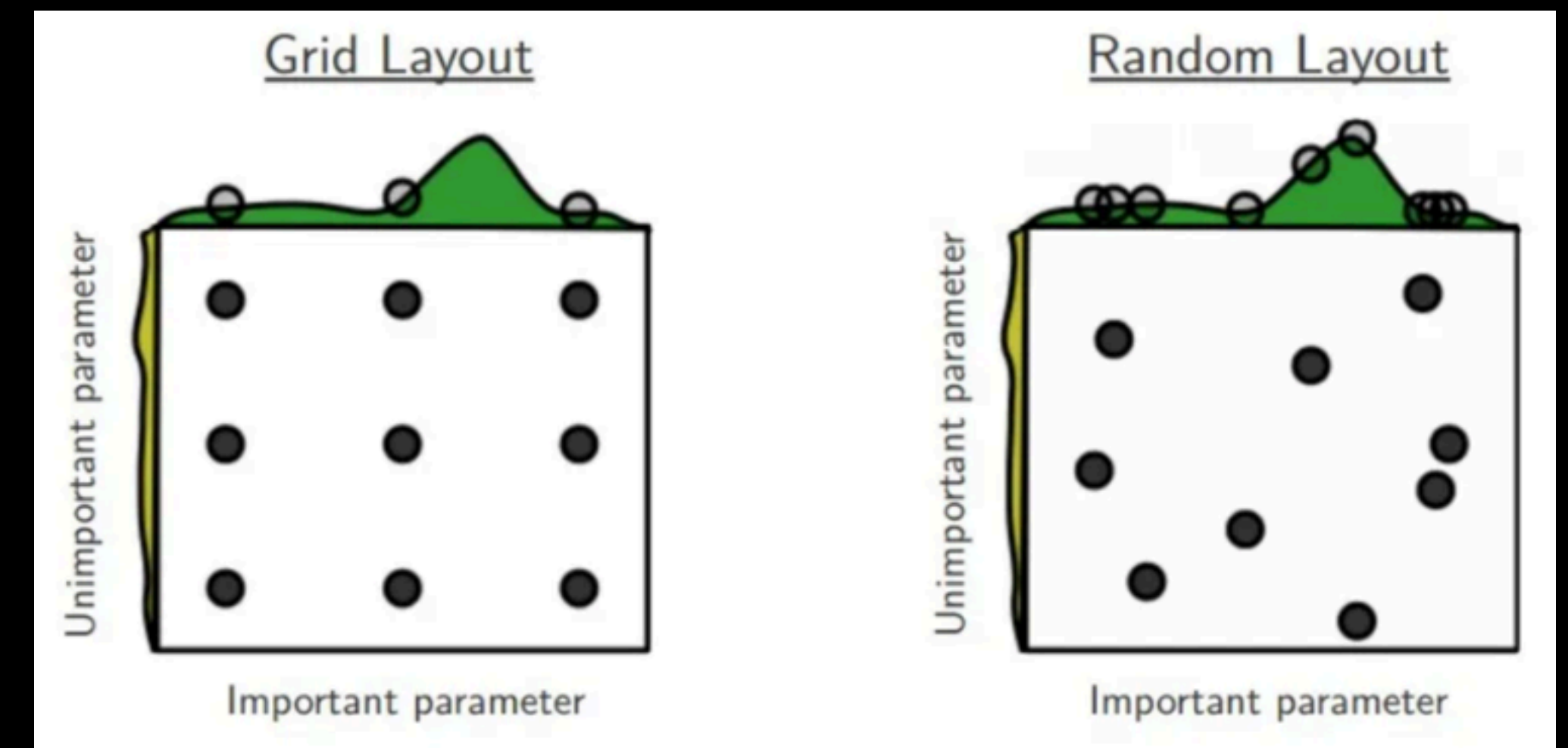

# Hyperparameter tuning

- Monitor validation loss for hyperparameter tuning
- Pay attention to signs of underfitting and overfitting

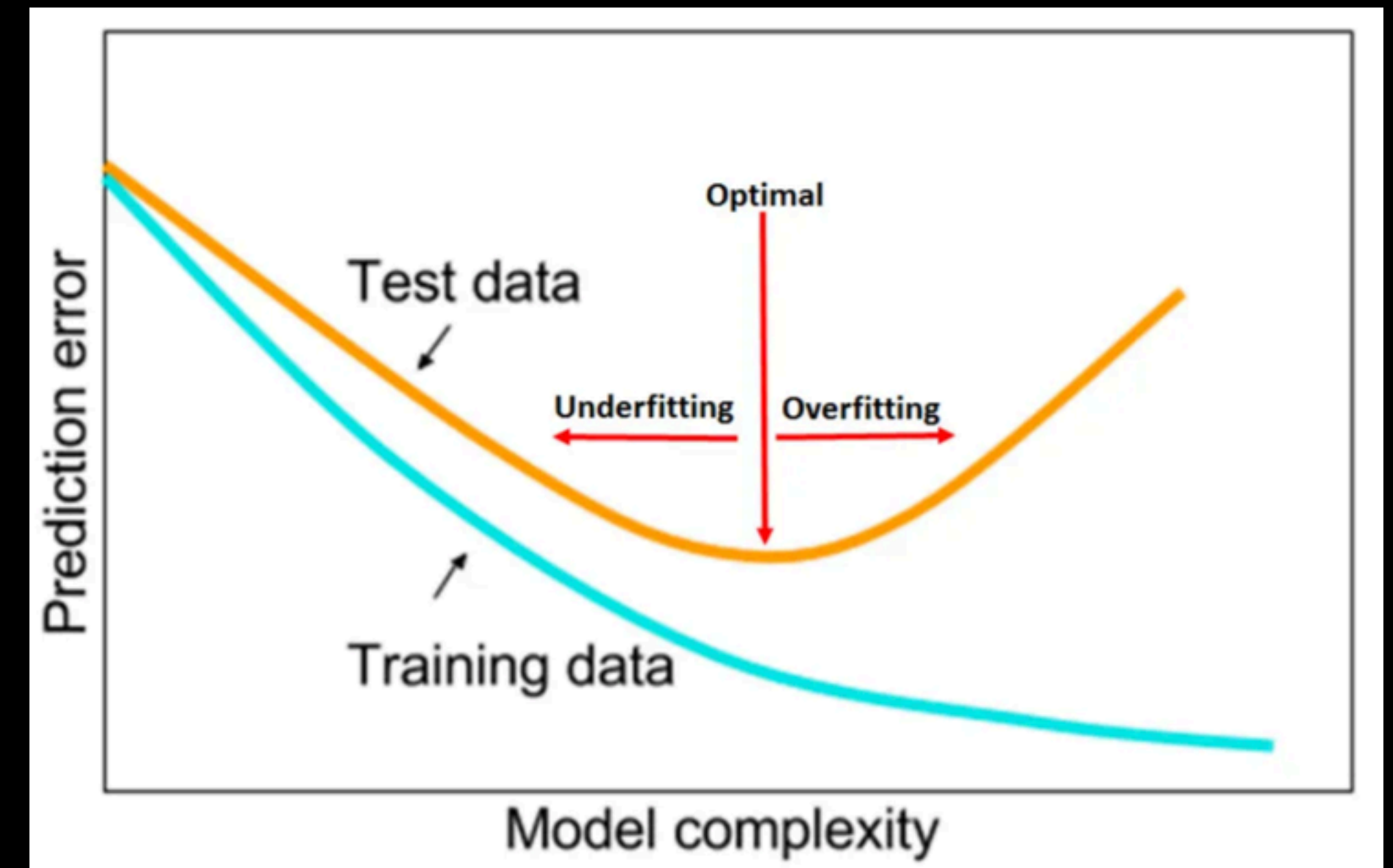

# Ablation study

- Ablation study investigates the performance of a neural network by removing one or several components at a time to understand the contribution from each component to the entire network.

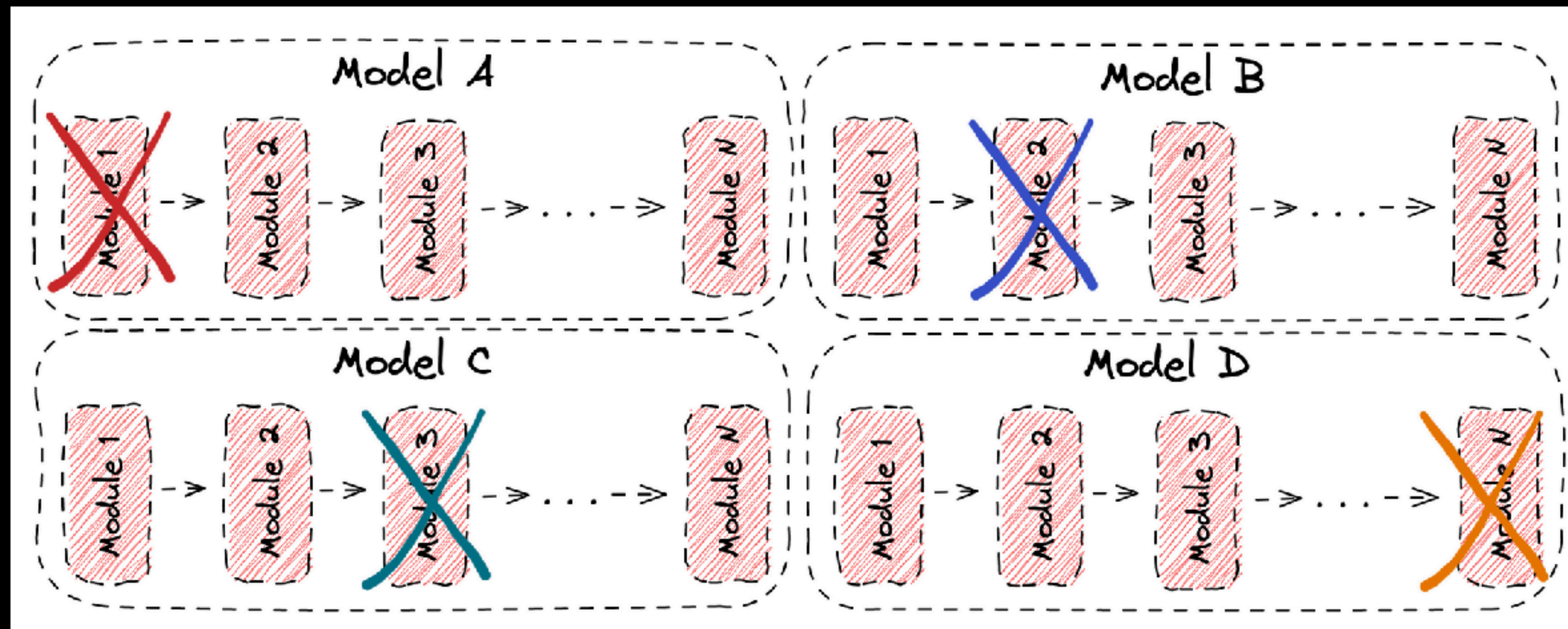

# Image quality evaluation

- Quantitative image quality metrics
  - NRMSE, PSNR, SSIM...
- Radiology scoring
  - Experienced radiologists review and rate the image quality
- Statistical analysis



# Deep learning-based MRI reconstruction

- Now we will show different deep learning-based MRI reconstruction
- We will focus on:
  - What kind of *problem* does it want to solve?
  - What kind of *approach* does it propose?

# (1) MoDL

- MoDL (Model-based Deep Learning architecture for inverse problem)
- Replace sparsity constraints (in CS formulation) with a deep learning network

Formulate as an optimization problem

$$x_{recon} = \operatorname{argmin}_x \left\| UFx - y \right\|_2^2 + \lambda \left\| x - \operatorname{ConvNet}(x) \right\|_2^2$$

An unrolled network with two main blocks

- (1) A ConvNet to reduce artifacts / improve image quality
- (2) A data consistency layer for k-space data consistency

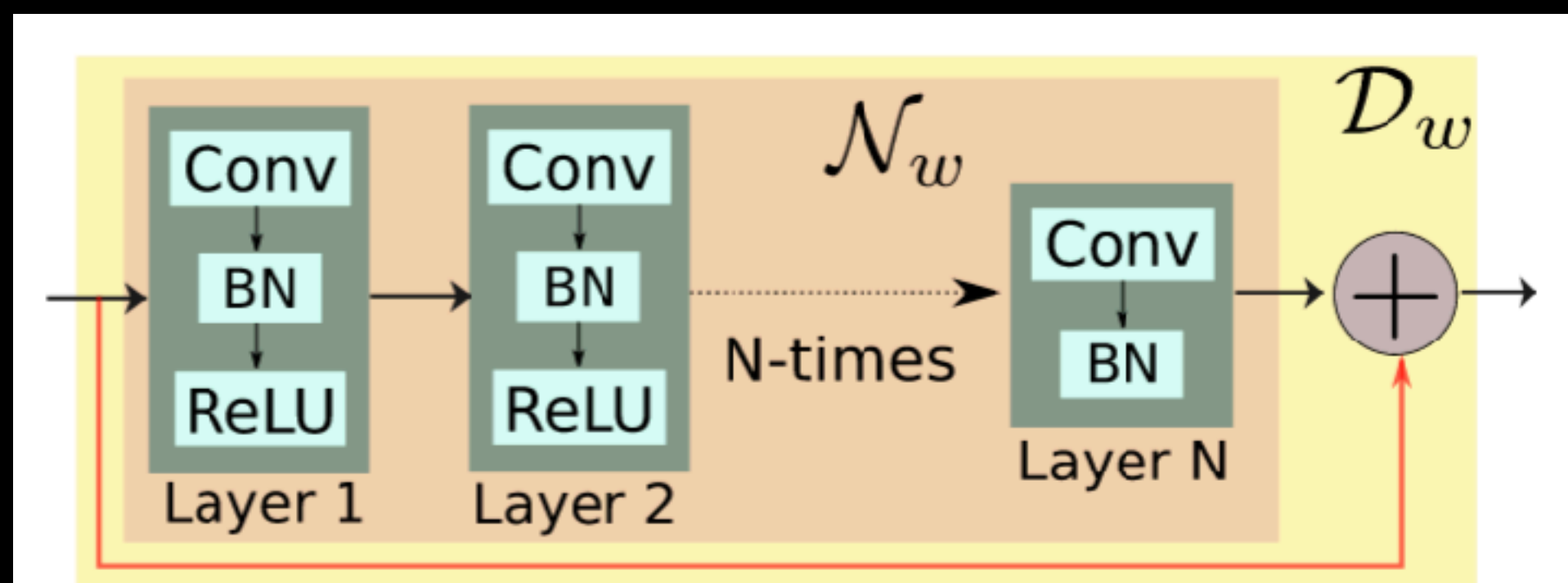

(a) The Residual learning based denoiser

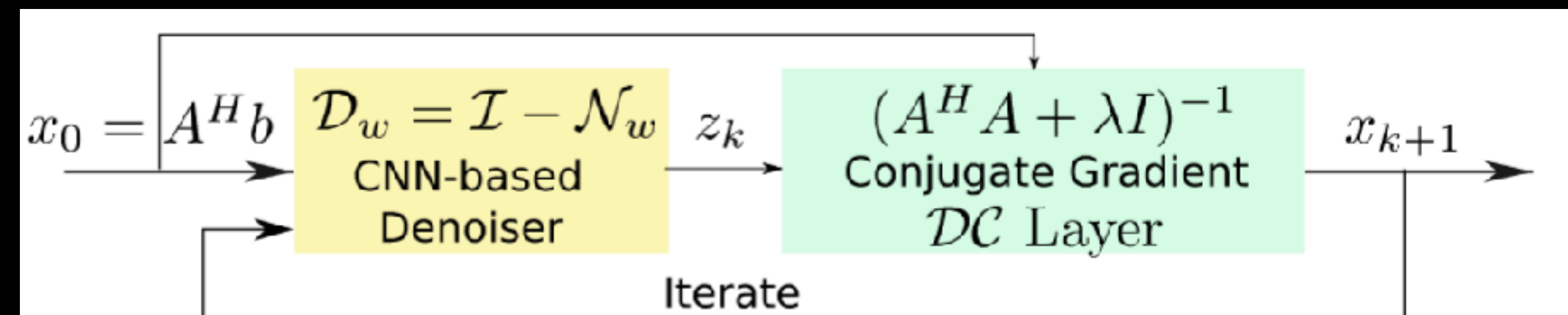

(b) Proposed Model-based Deep Learning (MoDL) architecture

# (1) MoDL

## Overall MoDL architecture

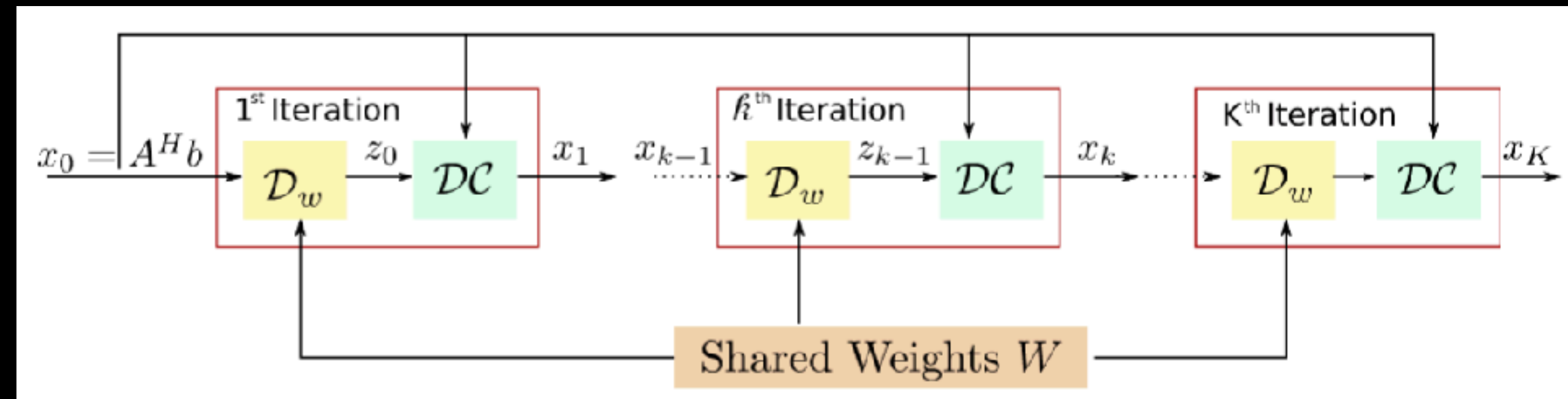

k-space sampling pattern

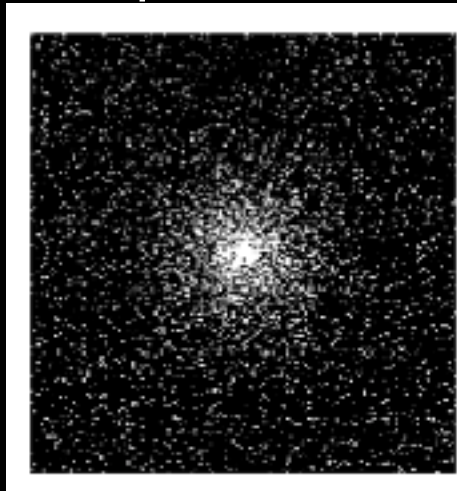
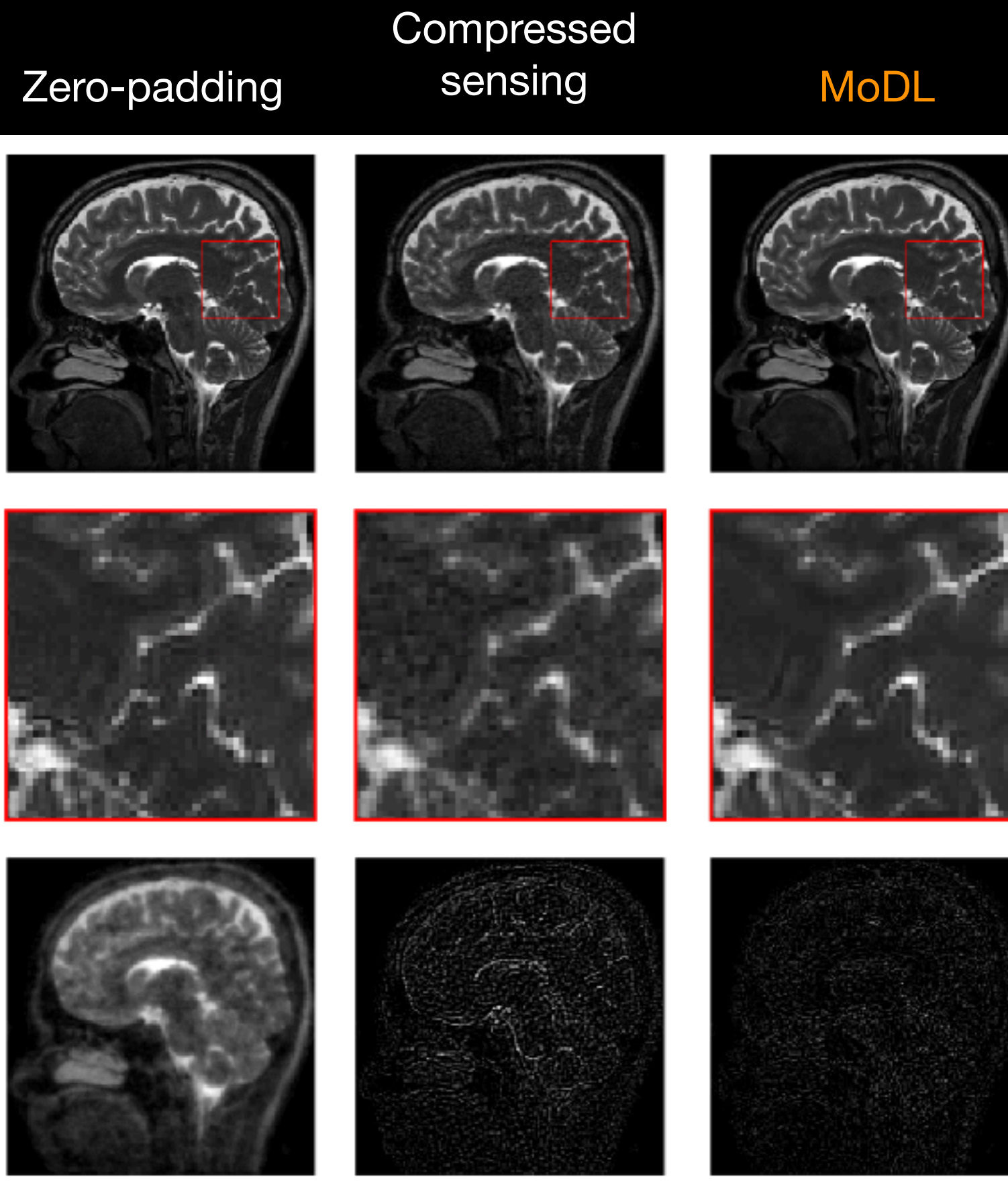

Image results



(Figures from: Aggarwal et al., IEEE TMI 2019)

## (2) KIKI-net

- KIKI-net<sup>1</sup>: Use cross-domain ConvNets for image reconstruction
  - One sub-network for k-space completion
  - One sub-network for image restoration

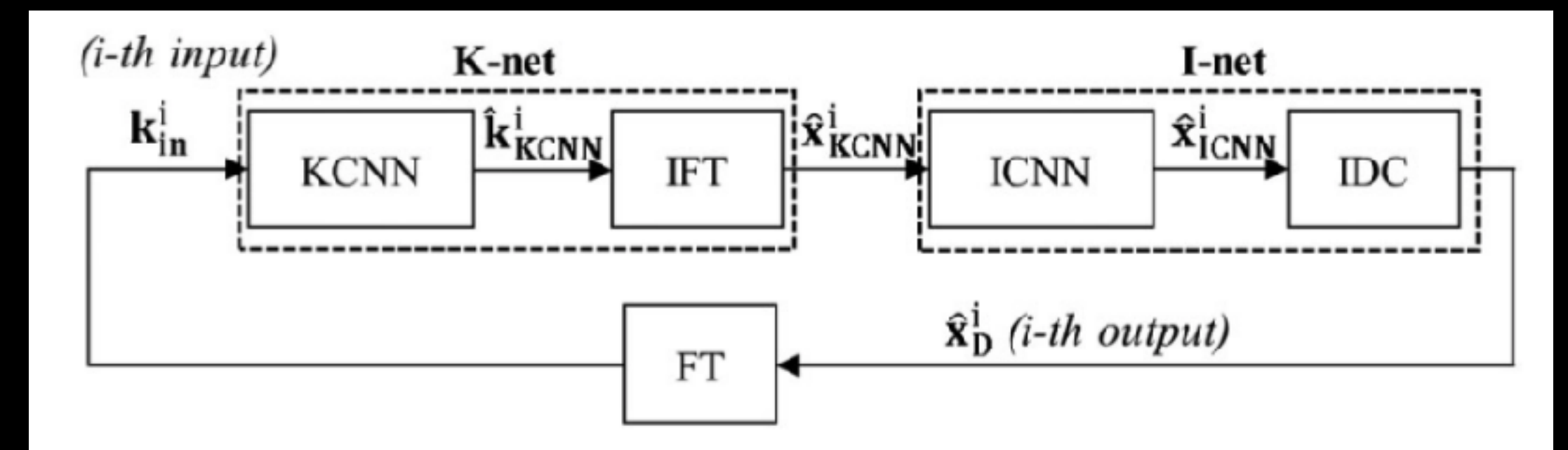
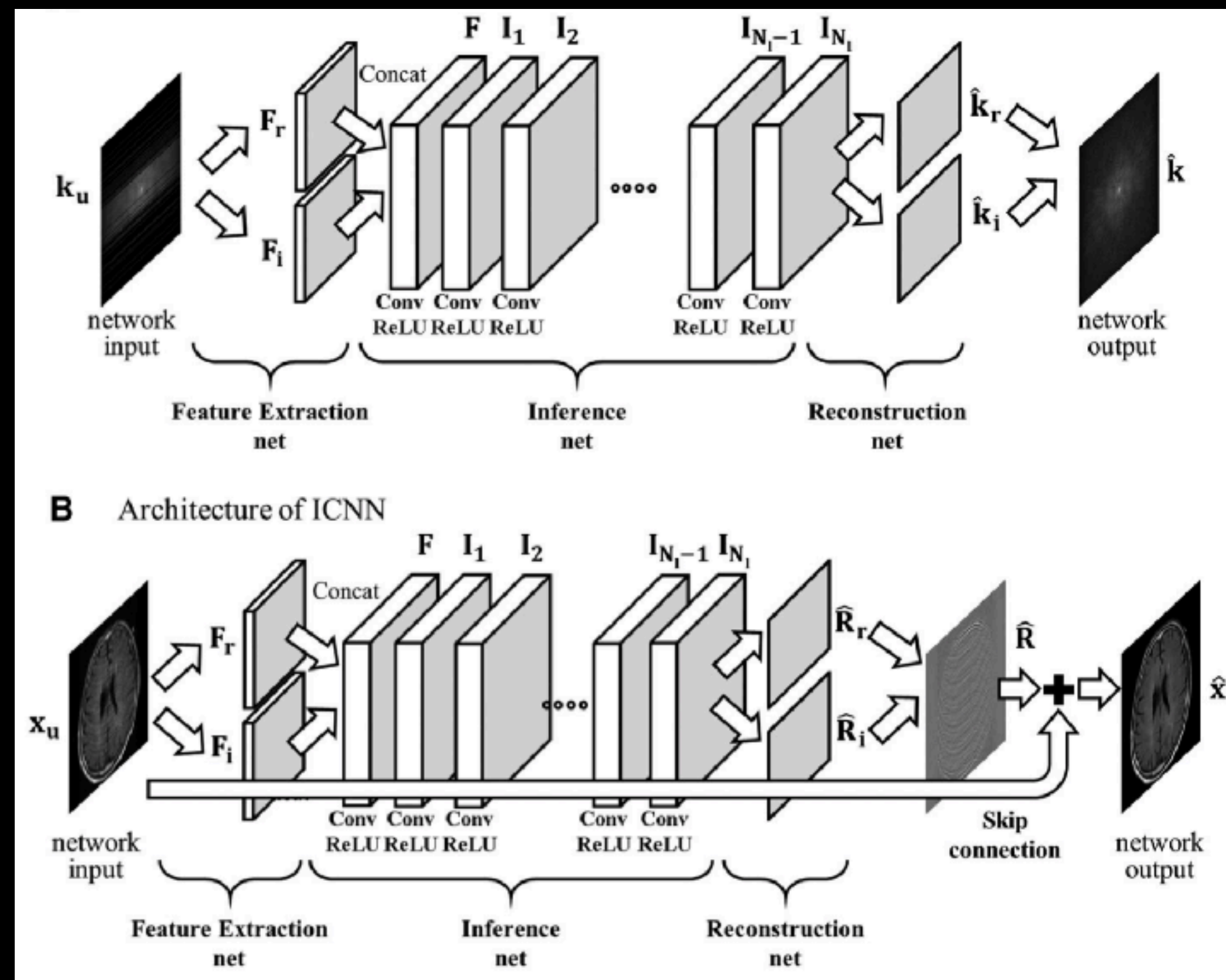

## (2) KIKI-net

Results from **single-domain CNN** vs. **cross-domain CNN**  
(undersampled factor  $R=4$ )

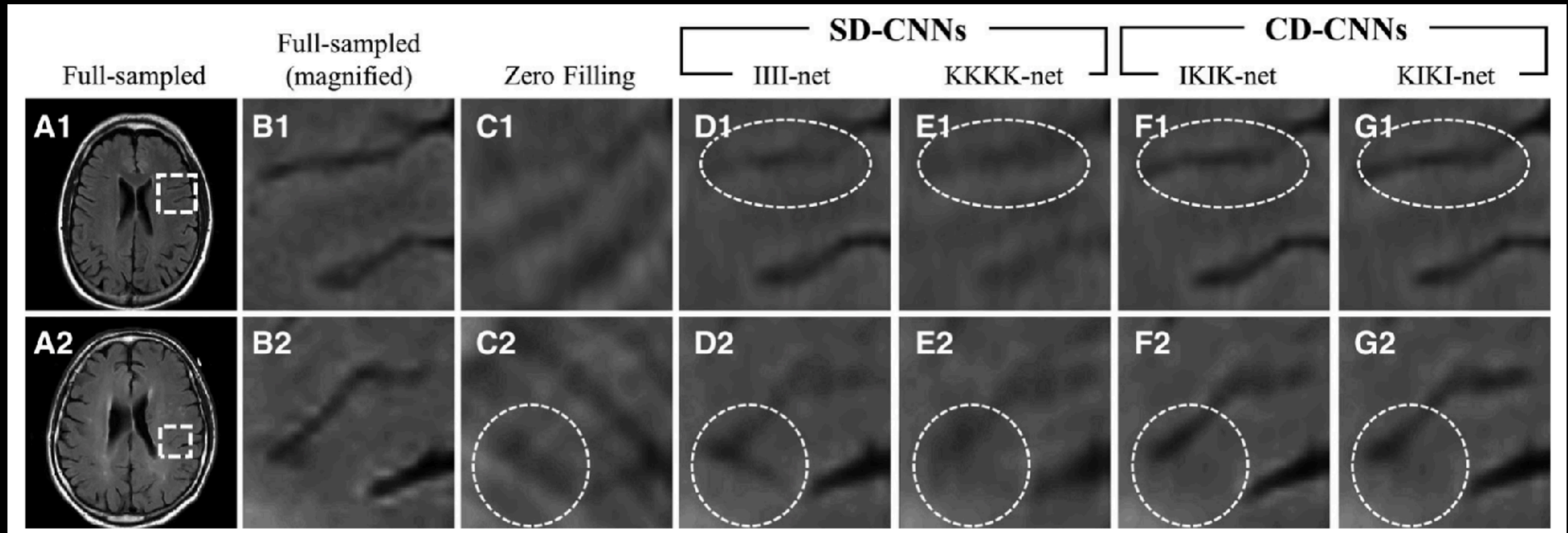

(Figure from: *Eo et al., MRM 2018*)

# (3) PKT

- PKT<sup>1</sup> (projection-based k-space transformer):
  - Use a transformer network with self-attention mechanism to predict missing k-space spokes in radial MRI

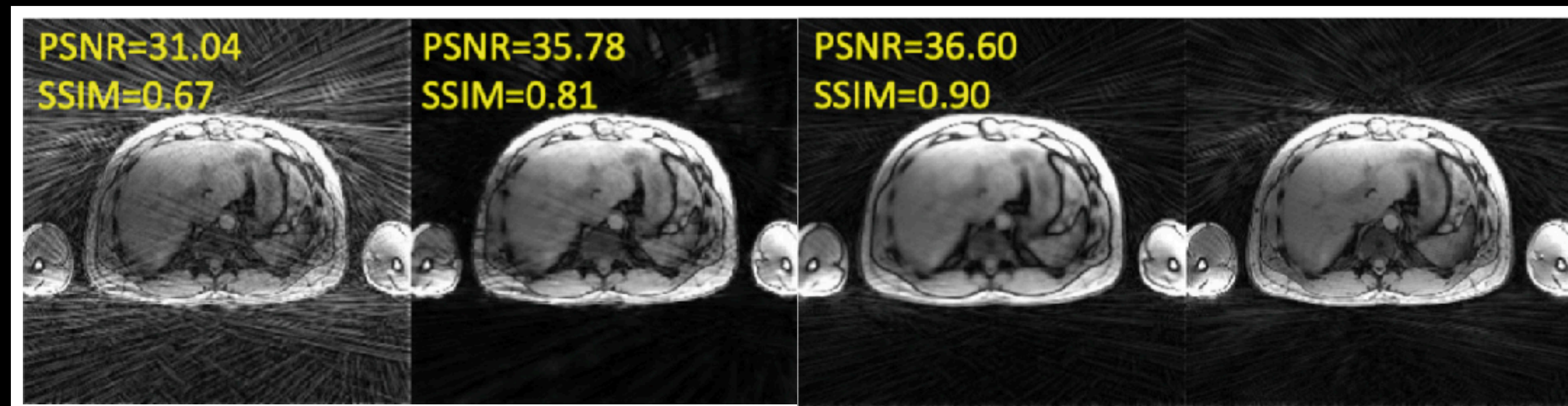
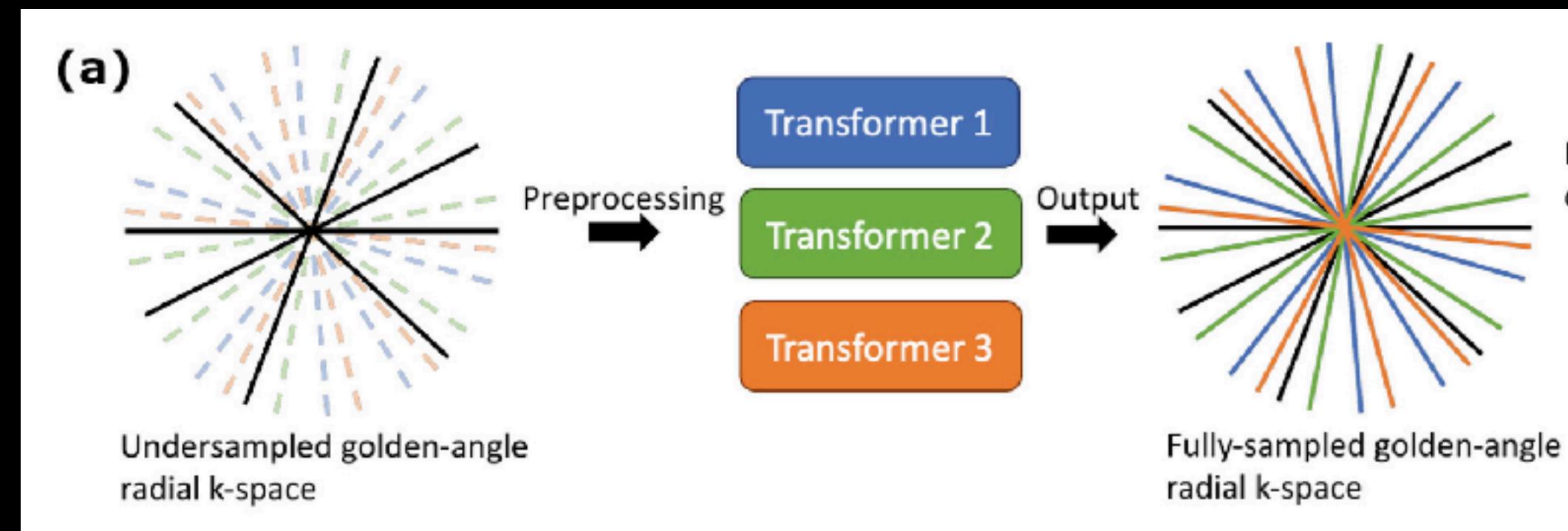

# (4) UP-Net

- UP-Net (Uncertainty-aware Physics-driven deep learning network)
- Uncertainty information incorporated into deep learning-based artifact suppression and parameter mapping

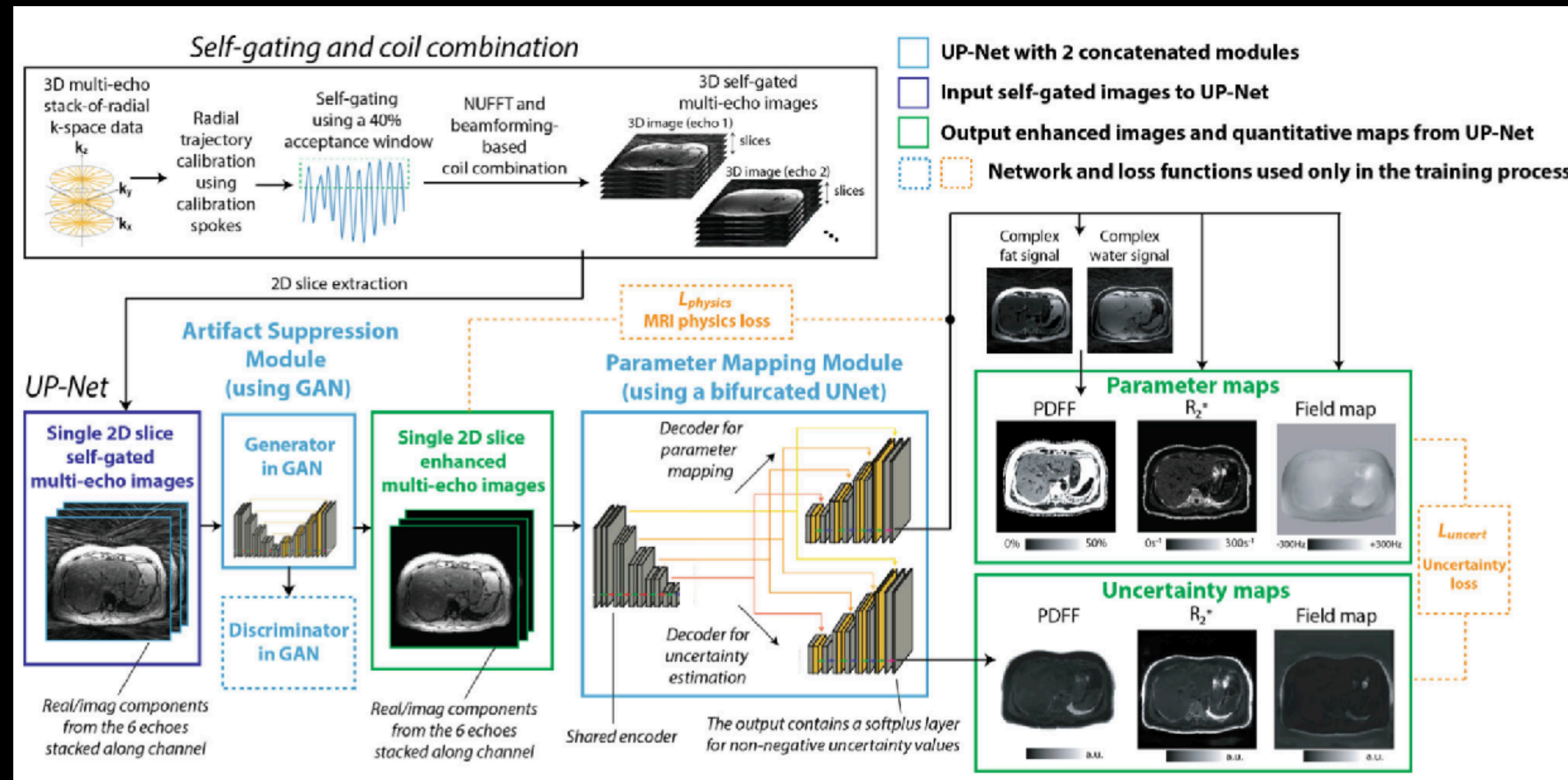

# (4) UP-Net

- Additional uncertainty map provided by the deep learning network can be used to estimate errors in the deep learning results

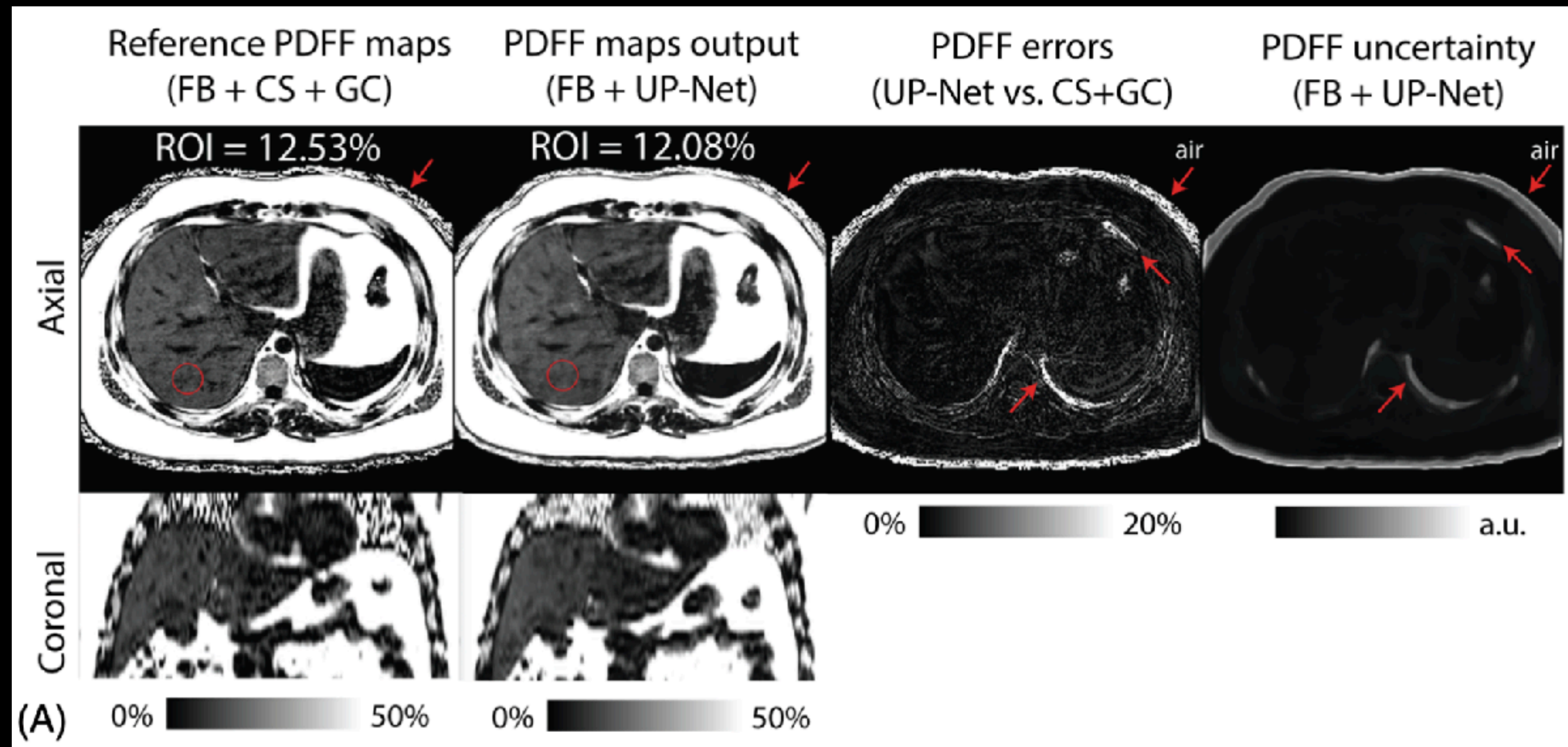



# (5) Self-supervised physics-guided reconstruction

- Self-supervised physics-guided reconstruction<sup>1</sup>
  - Deep learning reconstruction without fully-sampled reference dataset
  - Acquired k-space was split into 2 disjoint sets for self-supervision during training.

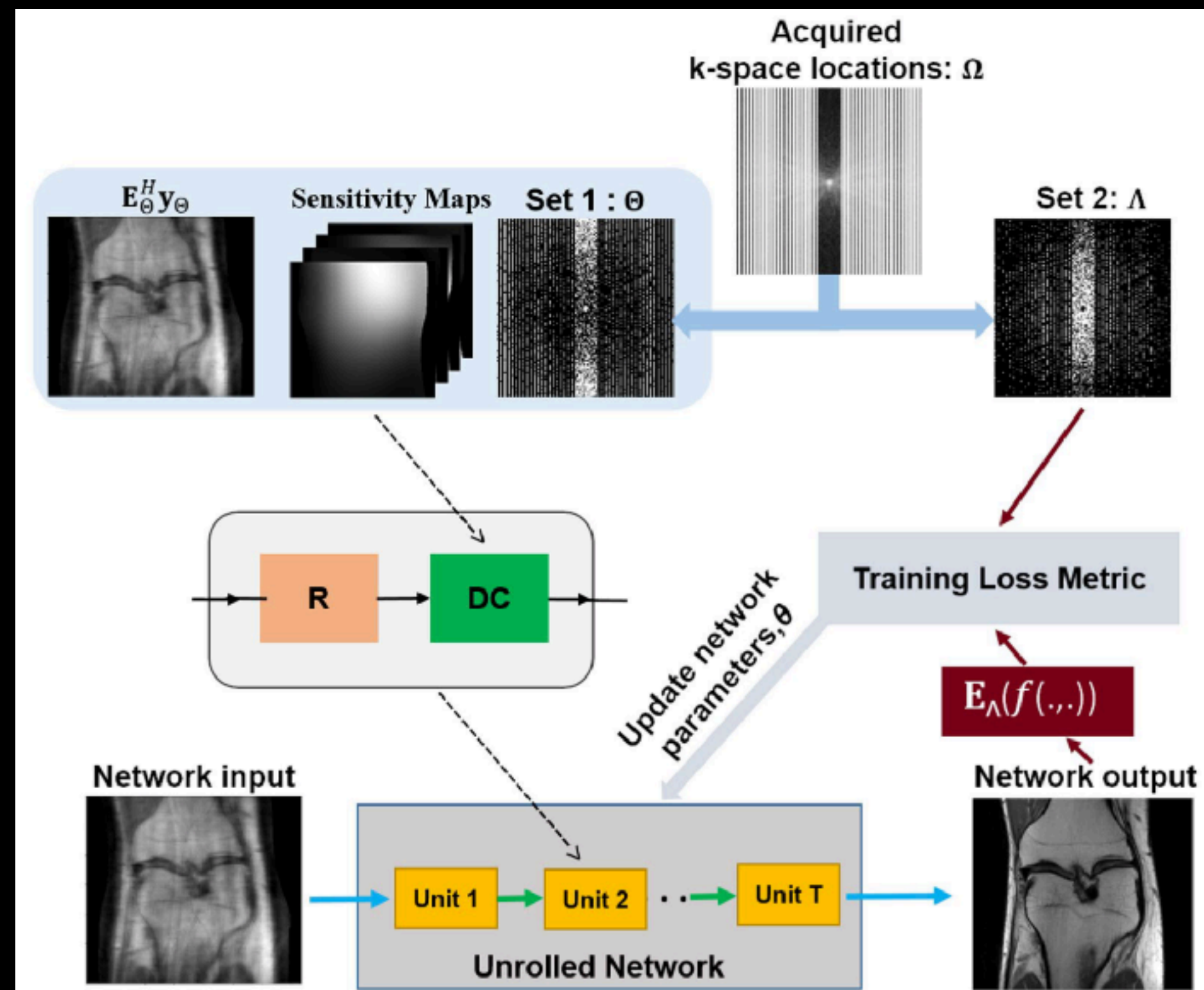

# (5) Self-supervised physics-guided reconstruction

- Image from self-supervised learning show similar performance compared to the supervised method.

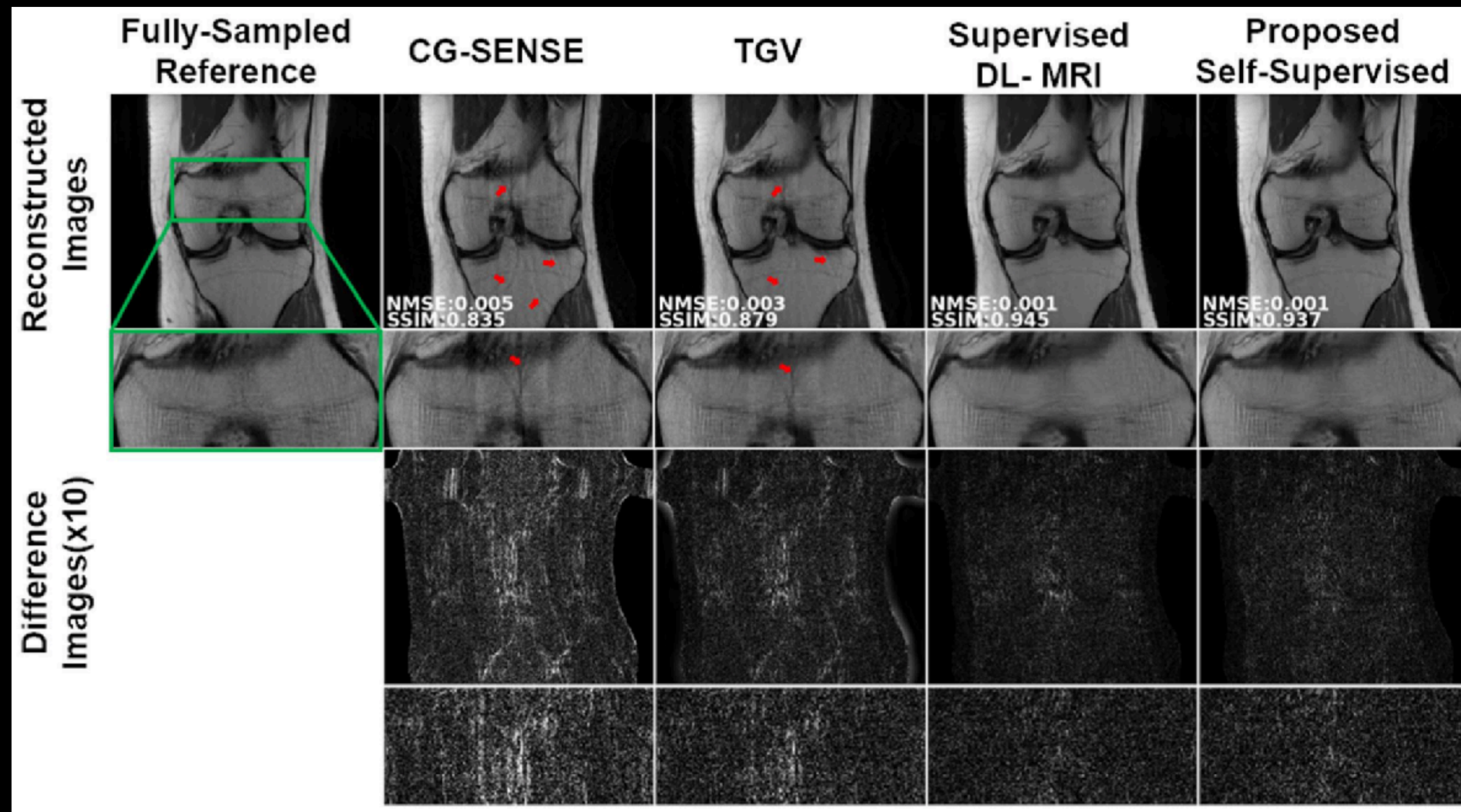

(Figure from: Yaman et al., MRM 2020 )

# (6) Active MRI acquisition

- Active MRI acquisition
  - Develop an *evaluator network* to rate the reconstruction uncertainty and the quality gain after each k-space line measurement
  - It is trained jointly with a *reconstruction network*.

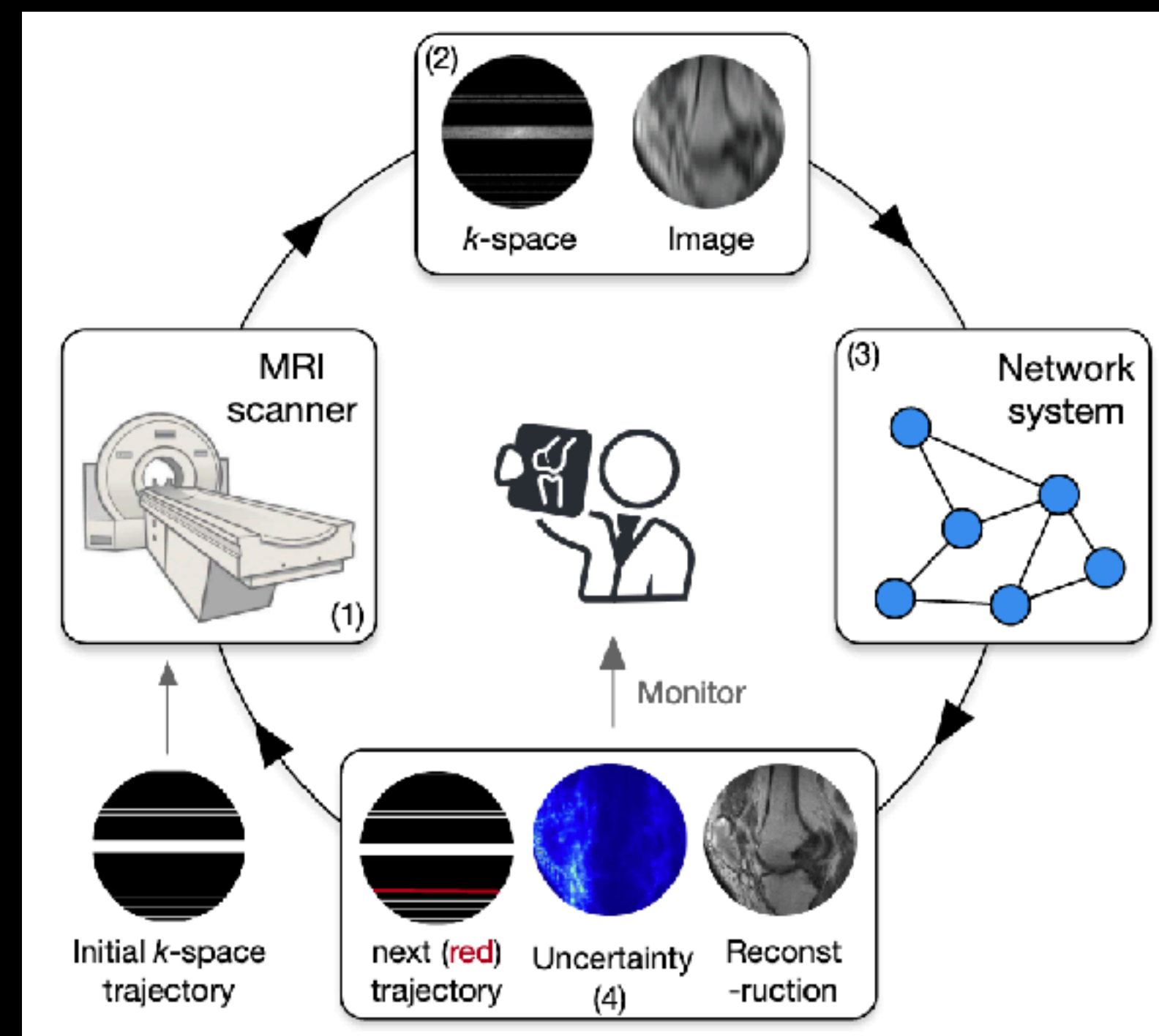

# (6) Active MRI acquisition

- The same undersampling pattern may not be suitable for all the cases.
- Deep learning-based uncertainty map was used to decide if sufficient data is acquired for faithful reconstruction.

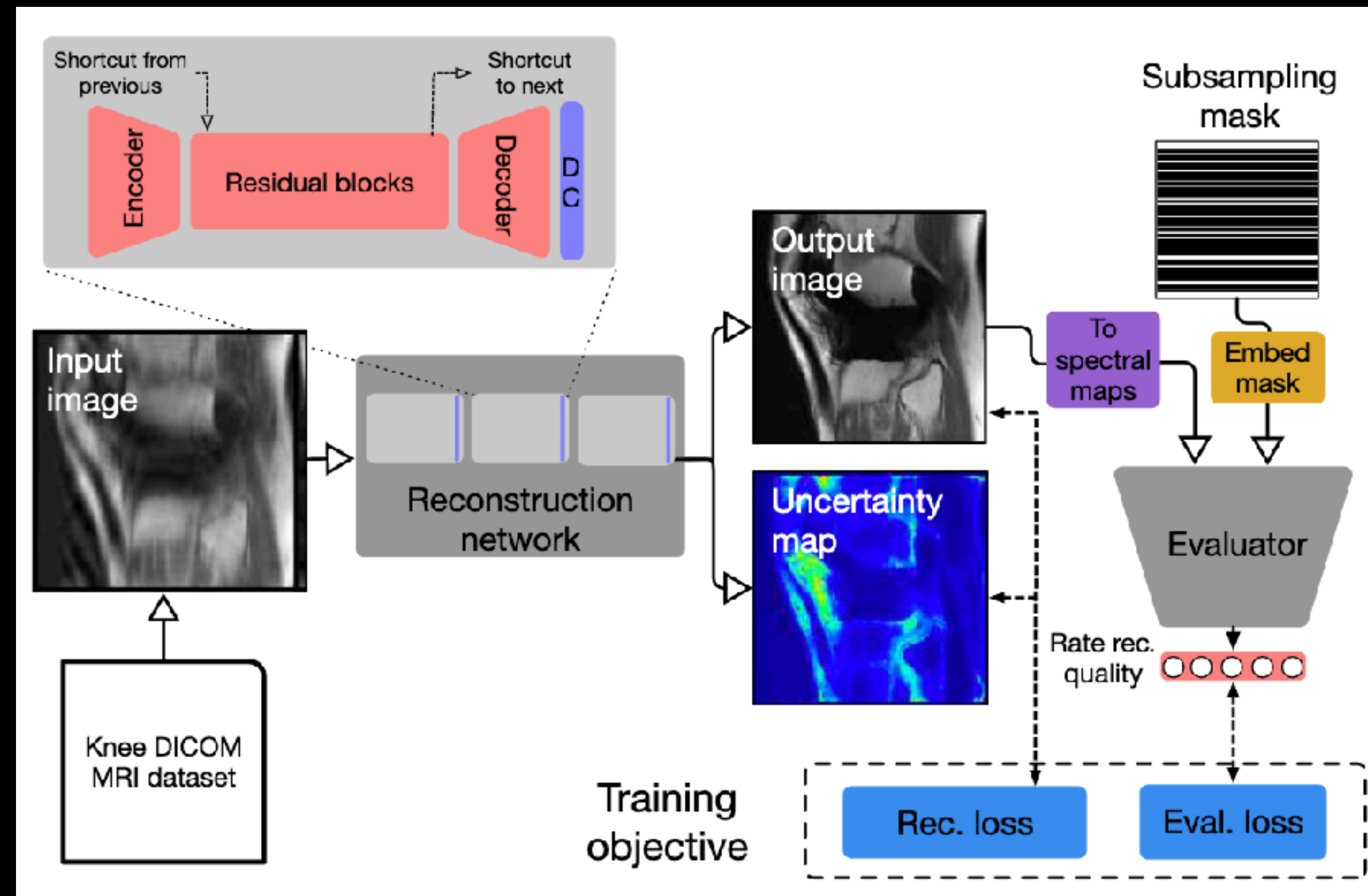

(Figure from: Zhang et al., CVPR 2019)

# (7) Joint reconstruction and trajectory optimization

- BJORK<sup>1</sup> (B-spline parameterized Joint Optimizations of Reconstruction and K-space trajectory)
- Use deep learning to find a suitable k-space trajectory for undersampled MRI reconstruction

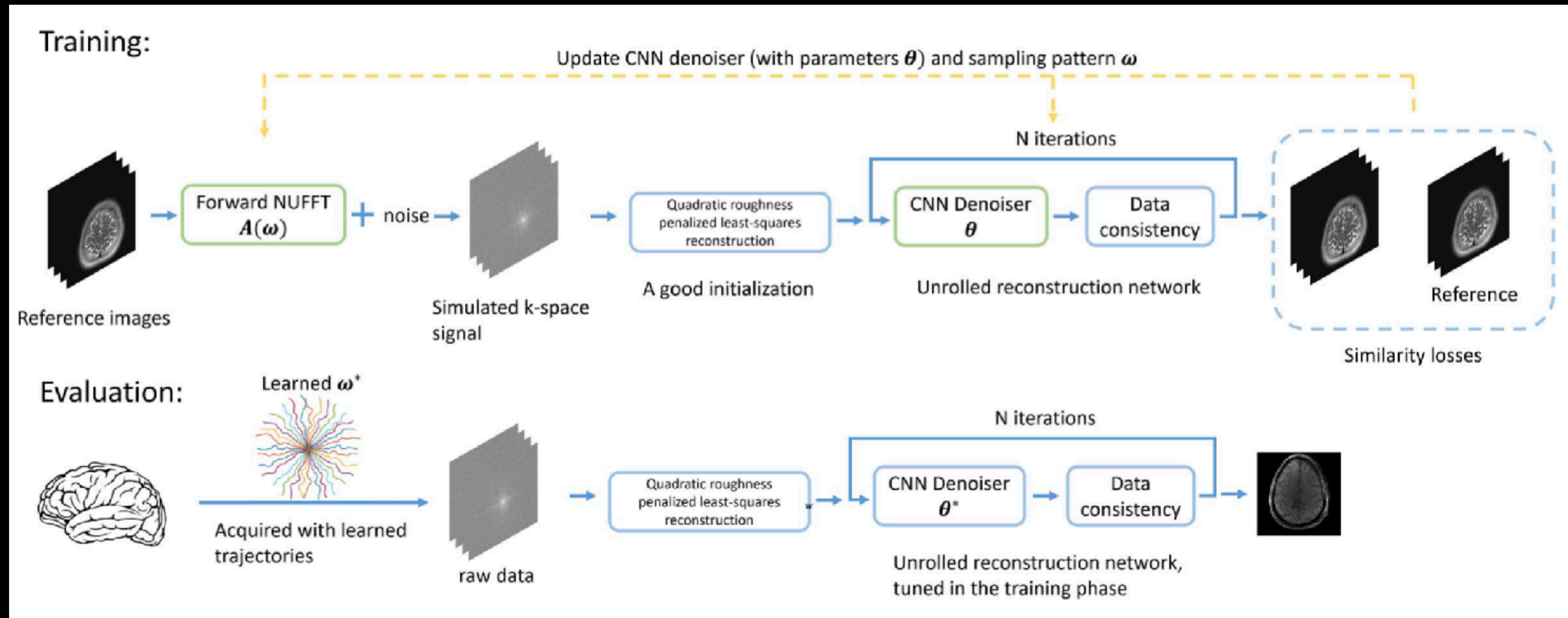

# (7) Joint reconstruction and trajectory optimization

Radial MRI and  
learned trajectory

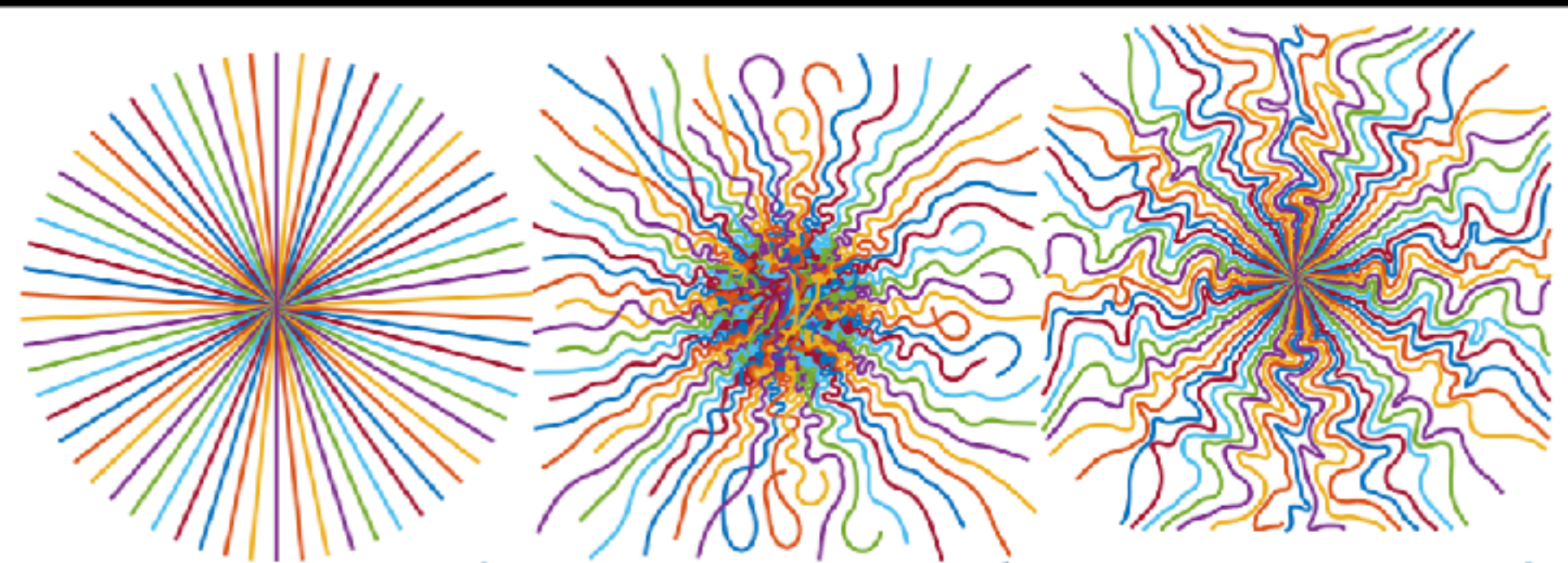

CS reconstruction

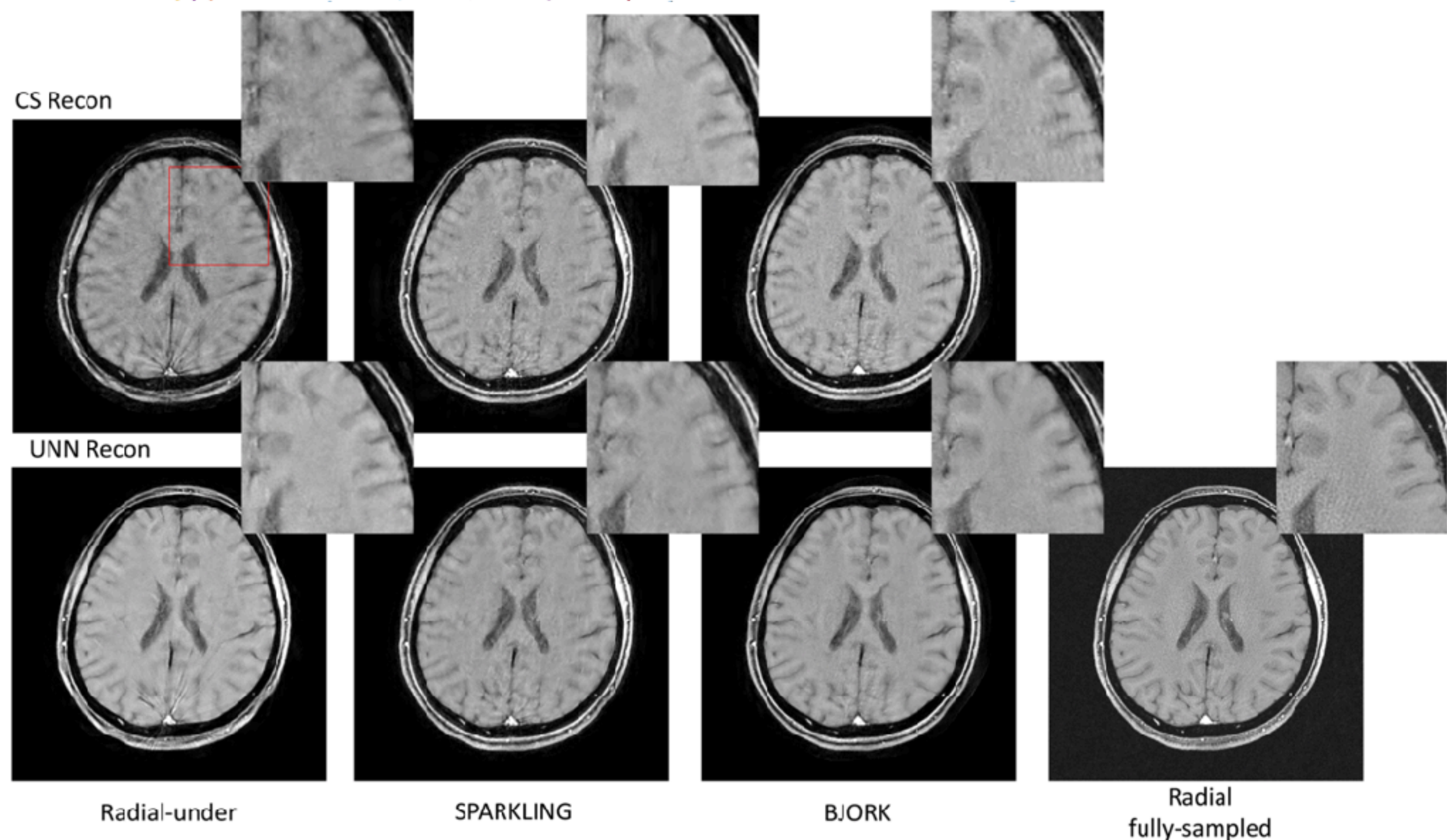

DL reconstruction

# Deep learning MRI reconstruction

- Deep learning neural networks are tailored for specific applications to solve specific problems.
- Many of the methods involve k-space data at some point. It can softly constrain the reconstruction results to be consistent with the acquired undersampled k-space data.
- Some applications requires multi-tasking (e.g., reconstruction + uncertainty estimation)

# Publicly available datasets for MRI reconstruction

- Public datasets with k-space data available
  - fastMRI** (<https://github.com/facebookresearch/fastMRI>)
    - Knee, brain and prostate MRI
  - SKM-TEA** (<https://github.com/StanfordMIMI/skm-tea>)
    - Quantitative knee MRI with tissue segmentation
  - M4Raw** (<https://github.com/mylyu/M4Raw>)
    - Multi-contrast multi-repetition 0.3T brain MRI
  - ... and more

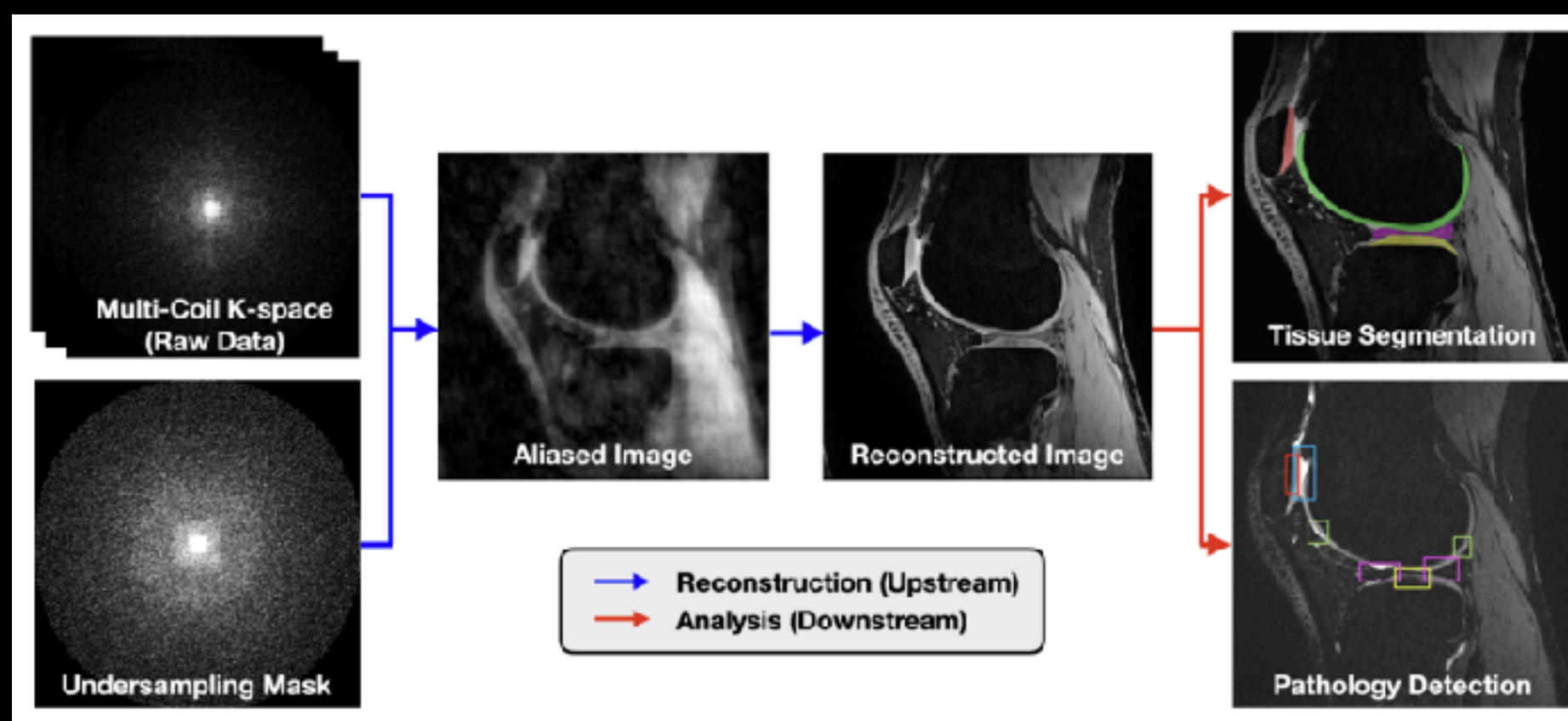
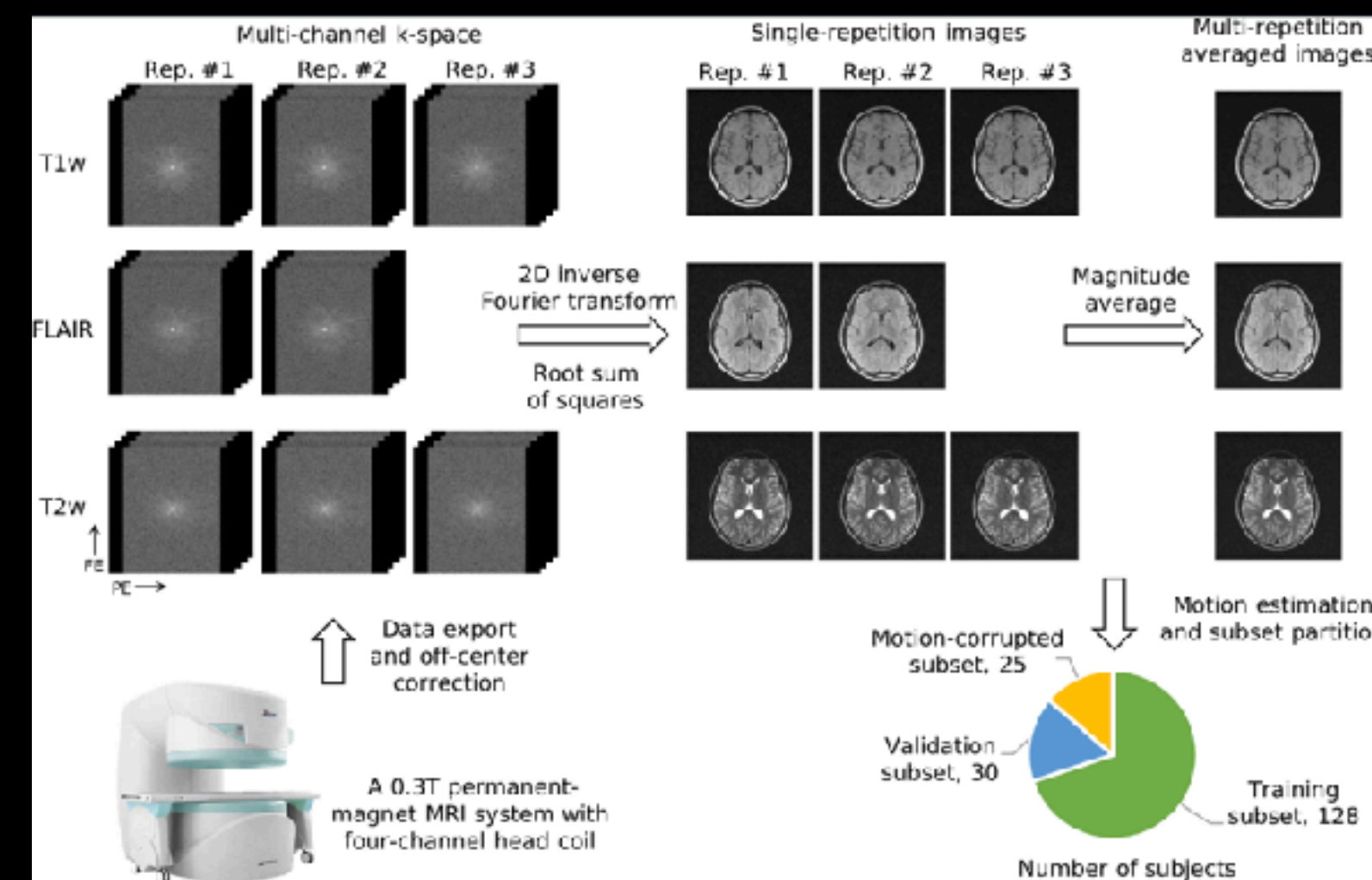

Welcome to the fastMRI Dataset

**Apply for Access**

The application process includes acceptance of the Data Sharing Agreement (found below) and submission of an online application form. The application must include the investigator's institutional affiliation and the proposed uses of the data. NYU fastMRI data may be used for internal research or educational purposes only as described in the data use agreement and may not be redistributed in any way without prior permission. Read and agree to the data use agreement below to apply for access.



# Discussion

- All major MRI vendors are working on deep learning-based MRI reconstruction
- There are many opportunities, but there are also many open questions.
- What are the limitations for deep learning-based MRI reconstruction?
  - Let's ask ChatGPT...

SH

What are the limitations for deep learning-based MRI reconstruction?

# A few personal suggestions...

- Focus on the problem you want to solve (*to improve image quality? to allow for higher undersampling factors? to train without ground truth images?...*).
- Have a good understanding on the deep learning tools you have. Choose or develop methods or architectures that can solve the problem.
- Understand your data and be aware of the MRI signal model and acquisition process. There can be constraints or there can be some prior information to utilize.
- Don't get lost in numbers! Don't forget the clinical problem.

# Thanks!

- Next time:
  - Managing Motion in MRI by Dr. Wu

Shu-Fu Shih

[sshih@mednet.ucla.edu](mailto:sshih@mednet.ucla.edu)